

# 2009 FOOTBALL OFFICIALS MANUAL For A Crew of 5 Officials

Edited and Published by  
Texas Association of Sports Officials  
Football Division  
3737 Executive Center Drive  
Suite 151  
Austin, TX 78731

(866) 283-TASO  
[www.taso.org](http://www.taso.org)

Revised March 2009

All rights reserved. No part of this manual, including text, pictures or illustrations may be reproduced in any form or by any means, electronic or mechanical, including photocopying, recording and storing or any retrieval system without permission from the Texas Association of Sports Officials Football Division.

## **PURPOSE OF MANUAL**

The manual of football officiating is designed to make available to each and every TASO official, detailed information regarding the officiating techniques which, through evaluation and studied development, have come to be recognized as accepted standards of officiating performance.

This manual is an authoritative guide to the best in football officiating, hopeful that it will assist all officials in maintaining their effectiveness and making ready use of their potentialities.

This manual is designed to provide the best possible officiating techniques for TASO officials working Texas High School Football. While these mechanics do not align perfectly with NCAA mechanics for a crew of 7, they will give officials the greatest opportunity to be successful while officiating in a crew of 5 officials.

TASO officials are expected to use the mechanics specified in this manual and are not authorized to deviate in any manner.

Copyright © 2009 by Texas Association of Sports Officials, Inc *All rights reserved*

No part of this publication may be reproduced, stored in a retrieval system or transmitted in any form or by any means, electronic, mechanical, photocopying, recording or otherwise, without the prior written permission of the publisher.

**TABLE OF CONTENTS**

	Section	Page
<u>Summary of 2009 Changes</u>		3
<u>Officiating Requisites</u>		4
<u>General Principles</u>	1	5
<u>Standard Uniform</u>	2	6
<u>Officiating Procedures</u>	3	8
<u>Pre-Game Duties On The Field</u>	4	9
<u>Toss</u>	5	10
<u>General Game Duties</u>	6	12
<u>Timing</u>	7	16
<u>Use of Bean Bags</u>	8	19
<u>Ball Handling</u>	9	20
<u>Free Kicks</u>	10	24
<u>Plays From Scrimmage</u>	11	26
<u>Running Plays</u>	12	34
<u>Forward Passes</u>	13	36
<u>Goal-Line Plays</u>	14	38
<u>Fumbles</u>	15	39
<u>Scrimmage Kicks</u>	16	39
<u>Try and Field Goal Plays</u>	17	41
<u>Time-Outs</u>	18	42
<u>Measurements</u>	19	44
<u>Calling Fouls</u>	20	45
<u>Close of a Period</u>	21	47
<u>One Minute Intermissions</u>	22	47
<u>Intermission Between Halves</u>	23	48
<u>Extra Periods</u>	24	49
<u>Post-Game Duties</u>	25	50
<u>Code of Ethics</u>		51
<u>Pre-Game Conference</u>		52
<u>Signals</u>		55

Copyright © 2009 by Texas Association of Sports Officials, Inc *All rights reserved*

No part of this publication may be reproduced, stored in a retrieval system or transmitted in any form or by any means, electronic, mechanical, photocopying, recording or otherwise, without the prior written permission of the publisher.

## SUMMARY OF APPROVED 2009 MANUAL CHANGES

### Editorial Changes

The manual has been reformatted to allow for easier use and readability. Sections have been expanded to include: pre-snap duties; changing “25-second clock” to “play clock”; and, new wording and diagrams for keys in the passing game.

Rationale: This manual is an authoritative guide to the best in football officiating, hopeful that it will assist all officials in maintaining their effectiveness and making ready use of their potentialities.

This manual is designed to provide the best possible officiating techniques for TASO officials working Texas High School Football. While these mechanics do not align perfectly with NCAA mechanics for a crew of 7, they will give officials the greatest opportunity to be successful while officiating in a crew of 5 officials.

### Movement by the L Punt Plays

Language reverted to 2007 version to allow **L** to leave when it is apparent the play is a kick.

Rationale: The previous change took coverage away from the short receivers and prevented the **L** from being in a position to help the **B**. While some change is warranted, we still must be cognizant of the fact that we cannot work 7-man mechanics with only 5 officials.

### Spotting the ball

Language has been added to clarify that the **U** is responsible for working the ball between the nine-yard marks.

Rationale: Most plays end with the **R** and/or **B** up to 20 yards away, while the **U** has worked into a position much closer to the end of the run, thus in more of a position to retrieve the ball allowing the **R** and/or **B** to take a wider view of the action after the play.

### Responsibility for determining forward/backward pass

Language added to play situations wherein a passer receives the snap and immediately throws the ball to the side zone. In the event this happens the **L** or **H** will be primarily responsible for determining if the pass is forward or backward.

Rationale: As the **R** is normally 14 to 18 yards behind the line of scrimmage and at a 45-degree angle from the snapper, it is difficult to determine the flight of the ball. The **H/L** will be able to assist in this function.

### Second half options

The second half options will be obtained from the sidelines, thus the captains do not meet at mid field.

Copyright © 2009 by Texas Association of Sports Officials, Inc *All rights reserved*

No part of this publication may be reproduced, stored in a retrieval system or transmitted in any form or by any means, electronic, mechanical, photocopying, recording or otherwise, without the prior written permission of the publisher.

**Identifying the player who commits a foul**

If equipped with a microphone, the Referee shall not announce the number of the player committing the foul.

**Plackets on uniforms**

Letters (R, U, H, L, and B) may be worn when working a televised game.

**Cold weather uniforms**

An allowance has been made for substituting an “NFL-style” pant for knickers during cold weather games.

## **OFFICIATING REQUISITES**

**COURAGE, A WORKING KNOWLEDGE OF THE RULES AND MECHANICS, HUSTLE, AND TACT** are indispensable to a good official, but none any more important than – **GOOD JUDGMENT!**

**RULES AND MECHANICS:** An overall familiarity with the rules and full understanding of mechanics are necessary for the proper conduct of a game. The intent of each rule must be kept in mind. Each official should seek the happy medium between strict adherence and undue laxity. Situations arise in a game which cannot be foreseen and which cannot be covered in a rule book or manual. Football “sense” must supersede the most technical application of the rules.

**COURAGE:** A smooth running game suddenly can get out of hand as a result of an overly officious attitude toward players and coaches, or an undue laxity of enforcement. Conversations with a coach or a player should always be courteous without sacrificing dignity. If something is said or done which warrants a penalty, penalization should be done unobtrusively and without dramatization. A game is kept under control by proper administration of the rules, which can be best accomplished if no impression of militant supervision is created.

**HUSTLE, BUT DON'T HURRY:** Hurry should not be mistaken for hustle. There are times it is proper to speed the tempo of the game in order to get the ball back in play after an incomplete pass, to take a position on a foul situation, to prepare for a measurement, etc. Never hurry an injured man off the field. Never rush to get another ball before the play is over. Don't move the ball to the inbounds line without first checking for the need of a measurement. Don't pressure a captain's decision on a difficult option. Precision and care should be exercised in all situations. Hustle is essential. HURRY is a hazard.

**TACT, BUT NOT SUBMISSION:** Tact is necessary but should never be a justification for retreat from a position properly taken or a decision correctly rendered.

**POISE, BUT NOT INDIFFERENCE:** Staying loose is an asset in officiating, as in any other phase of a sport where fast reflexes are required. A relaxed appearance is a great help if it gives the impression of confidence. Care, however, should be taken to avoid the appearance of indifference. The poised official is able to remain inconspicuous as he moves to the right place at the right time.

Copyright © 2009 by Texas Association of Sports Officials, Inc *All rights reserved*

No part of this publication may be reproduced, stored in a retrieval system or transmitted in any form or by any means, electronic, mechanical, photocopying, recording or otherwise, without the prior written permission of the publisher.

## **SECTION 1. GENERAL PRINCIPLES**

**ARTICLE 1. KNOWLEDGE OF THE RULES:** Rule mastery will be perfected over time, and must be supplemented by ability to interpret rules and editorial changes correctly. These abilities are acquired through devotion of time and study.

**ARTICLE 2. PHYSICAL CONDITION:** Football officiating is difficult and exhausting and requires 100 percent efficiency of mind and body. An annual physical examination should be a personal requisite to ensure your health, thus allowing you to assess your ability to officiate.

**ARTICLE 3. MENTAL REACTIONS:** Decisions must be instantaneous and rulings announced without delay. To ensure improved instinctive reaction to play situations, continue to review the different combinations of circumstances that may occur.

**ARTICLE 4. DUTIES AND RESPONSIBILITIES:** Each official must have a thorough knowledge of the duties of his own position and must also be fully informed concerning the duties of each of the other officials. He/she should be prepared to assume any one of the other positions whenever circumstances require rearrangement of assignments.

### **AN OFFICIAL MUST:**

- A. Know the down and yardage prior to each snap.
- B. Be ready to assist any official that is temporarily out of position.
- C. Observe erroneous procedure or rulings of other officials and attempt prevention and correction whenever possible. Under no circumstances should an argument develop on the field between officials.
- D. Know the prescribed signals and when and how they should be used.
- E. Secure a new ball if appropriate, after all action has ceased and be able to handle and pass the ball properly.
- F. Be alert to happenings away from the ball when play has left his immediate area.
- G. Call time-out for any player who is obviously injured or disabled. Never hurry the treatment of an injured player. Recognition of injured players is the concern of all game officials. Clock can be started if time-out is not necessary.

**ARTICLE 5. SIGNALS:** All signals should be given promptly, distinctly and conspicuously as they are the non-verbal communications tools we use to inform. The preliminary signal on fouls and the regular signal after enforcement (or declination) of a penalty shall be given by the Referee only. (See Code of Signals).

**ARTICLE 6. ENFORCEMENT:** All rules should be strictly and fairly enforced. There shall be no deviation from the NCAA Football Rules with UIL exceptions.

**ARTICLE 7. HUSTLE:** Keep the game moving smoothly from start to finish. Do not permit haste to interfere with duties or correct determinations.

**ARTICLE 8. BOXING IN:** Smart officiating requires keeping the players "boxed in" and avoidance of officials being "boxed in". "Outside looking in" is essential for sideline and end line coverage. The ultimate goal is to have each play viewed from more than one direction.

Copyright © 2009 by Texas Association of Sports Officials, Inc *All rights reserved*

No part of this publication may be reproduced, stored in a retrieval system or transmitted in any form or by any means, electronic, mechanical, photocopying, recording or otherwise, without the prior written permission of the publisher.

**ARTICLE 9. OFF BALL OFFICIATING:** Officials should not be ball watchers. The official nearest the action should take the primary responsibility for the ball, but should also be alert to action around the ball. The official that is the farthest distance away should take the widest, “big picture” view of the action, looking for unsportsmanlike acts and threats to player safety. The officials in between should work in “rings”. The closer you are to the ball, the smaller your “ring” is.

**ARTICLE 10. COOPERATION:** Team work is essential among officials. If a ruling is puzzling, relay explanation to press box. Never issue direct or indirect newspaper interviews, statements or stories concerning games in which you are an official. Continuous verbal and non-verbal communication between all officials during the game is essential for effective game administration.

**ARTICLE 11. DON'T DISCUSS:** Do not discuss with a coach the play or players of his opponents in a game which you will officiate or are officiating. Coaches and other school representatives are expected to submit reports on work of officials to the governing authority and not to make evaluations through conversation with other officials or through public statements.

**ARTICLE 12. OFFICIALS' “ABCs”**

A - Ability to handle players in firm, fair, and friendly fashion.

B - Knowledge, understanding and correct application of the rules.

C - Knowledge of an adherence to approved mechanics.

**ARTICLE 13. WHEN IN QUESTION RULES:**

A. Catch or recovery not completed (2-2-7).

B. Block below the waist (2-3-2).

C. Chop block (2-3-3).

D. Block in the back (2-3-4).

E. Ball not touched on kick or forward pass (2-10-4).

F. Ball is accidentally kicked (touched) (2-15-1).

G. Forward pass and not fumble (2-19-2).

H. Forward pass rather than backward pass (2-19-2).

I. It is a catchable forward pass (2-19-4).

J. Stop clock for injured player (3-3-5).

K. Forward progress stopped (4-1-3).

L. Kick catch interference (6-4-1).

M. Reasonable opportunity to catch (7-3-2).

N. It is catchable forward pass (7-3-8).

O. Touchback rather than safety (8-5-1).

P. Roughing kicker rather than running into (9-1-3).

Copyright © 2009 by Texas Association of Sports Officials, Inc *All rights reserved*

No part of this publication may be reproduced, stored in a retrieval system or transmitted in any form or by any means, electronic, mechanical, photocopying, recording or otherwise, without the prior written permission of the publisher.

## SECTION 2. STANDARD UNIFORM

**ARTICLE 1. TRADITIONAL UNIFORM:** It is essential that all TASO football officials dress in a consistent manner. All members of a crew must be similarly dressed. For all varsity games the uniform worn by all officials shall include the following:

A. **SHIRT** - Standard black and white knit, long tail, one inch vertically striped officials' long and short sleeve shirts with pocket on the left breast, without emblems and complete with knit black "Byron" collar and black cuffs. All members of each crew must wear either long or short sleeve shirts. Mesh shirts may be worn if entire crew is so garbed.

B. **KNICKERS (Pants)** - Standard all white, tapered, regulation football officials' knickers shall be worn with a slight overlap below the knees (not more than four inches).

In cold weather, the knickers may be replaced with an "NFL-type" black pant. The pants must be worn by the entire crew. The pants must be accompanied by regulation, long-sleeved shirts. The pants must include a one-inch white strip on the seam of the leg, must not be cuffed, and must continue to the shoe without a break.

C. **STOCKINGS (Socks)** - Black stockings with:

1. White above the top of the shoe heel not less than three inches and not more than four inches.
2. Two inches and not more than two and one quarter inches Black between the top of the white and the bottom of the lowest white stripe.
3. Alternating stripes, white (1/2-5/8"), black (1/2-5/8"), white (1-1 1/4"), black (1/2-5/8"), white (1 1/2-5/8").
4. Black between the top of the top white stripe and the bottom of the knickers not less than two inches and not more than two and one quarter inches.

When wearing approved pants, other than knickers, officials will wear black socks.

D. **SHOES AND BELT** – Predominantly black shoes with black laces and appropriate soles or cleats. A black belt, a minimum of one and one-quarter inches and a maximum of two inches in width shall be worn.

E. **CAP** - Brooklyn style solid black cap with white piping (without emblem or numbers) shall be worn by all but the Referee, who shall wear a Brooklyn style solid all-white cap. The cap shall be oriented with the bill facing forward and squarely covering the forehead of the official.

F. **FOUL MARKER** - All officials shall be equipped with a light gold foul marker, 15" X 15" and weighted in the center with pebbles, sand or beans and worn *INCONSPICUOUSLY*.

G. **BEAN BAGS** - All officials will be equipped with one or more **white** bean bags for marking spots. Bags shall be filled with pebbles, sand or beans.

H. **JACKETS** – Jackets are not considered part of the official uniform.

Copyright © 2009 by Texas Association of Sports Officials, Inc *All rights reserved*

No part of this publication may be reproduced, stored in a retrieval system or transmitted in any form or by any means, electronic, mechanical, photocopying, recording or otherwise, without the prior written permission of the publisher.

I. **UNDERSHIRTS** - All undershirts which show should be black.

J. **GLOVES** - Gloves when worn shall be black.

K. **NUMBERS, LETTERS, AND EMBLEMS** – A 2"x3 3/8" American Flag will be worn on the left sleeve affixed 2" below the shoulder inseam. Numbers, letters, and emblems visible on uniform or equipment are prohibited, except as may be specifically directed by the TASO Football Board of Directors or the TASO Executive Director. Requests for memorial or other special insignia or emblems must be submitted to the Executive Director for approval.

When officials are working a game that will be televised live in its entirety, the crew may opt to wear letters or plackets. The plackets must be worn by the entire crew and must be professionally attached to the shirt. The letters shall align with the TASO mechanics manual, i.e. R, U, H, L, and B.

**ARTICLE 2. TASO-Football APPROVAL:** All uniforms meeting the above specifications are approved by the TASO-Football Division board of directors.

**ARTICLE 3. UNIFORM CHECK:** Check your uniform and equipment before leaving home and again check each other's uniform prior to the game. Test whistle, watch (carry spares) have game data cards, foul marker, bean bag(s), a down indicating device and pencils. Have shoes polished and entire uniform neat and clean.

**ARTICLE 4. SUMMER UNIFORM:** A "summer uniform" is approved for wearing in scrimmages and sub-varsity, in accordance with Chapter policy, but all in the crew must wear the same uniform. A "summer uniform" is a traditional uniform with black shorts rather than knickers and white socks rather than striped stockings.

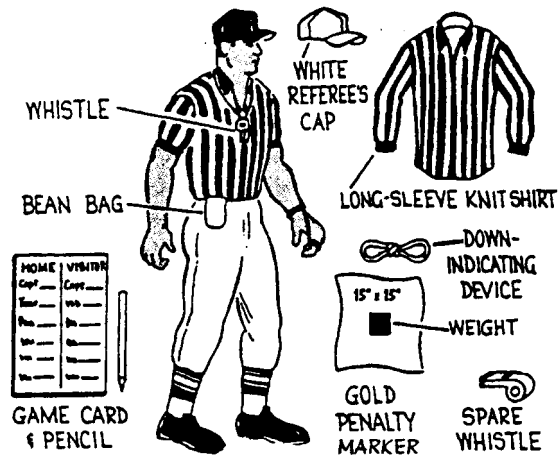

**SECTION 3. OFFICIATING PROCEDURES**

**ARTICLE 1. BEFORE ENTERING FIELD**

Copyright © 2009 by Texas Association of Sports Officials, Inc *All rights reserved*

No part of this publication may be reproduced, stored in a retrieval system or transmitted in any form or by any means, electronic, mechanical, photocopying, recording or otherwise, without the prior written permission of the publisher.

**ALL A.** Attendance at the pre-game conference at least one (1) hour before scheduled game time is mandatory for varsity games. Only an emergency and notice to the Referee may excuse an absence.

**H B.** In the absence of the **R**, you are responsible to ensure that a pre-game conference is conducted. A pre-game conference guide is provided in this manual as a tool to help prepare for and deliver a pre-game conference.

**U C.** If not provided, arrange dependable transportation to and from the stadium.

**B D.** Make certain you have correct time. Other officials will check their watches with yours.

Playing time shall be kept with a game clock which may be either a stopwatch, operated by the **B** or a field clock, operated under the direction of the **B**.

Take over game balls from **R**; and take them to field just before game time. Have stopwatch or watches ready if necessary.

Ensure that you have an accurate timing device for timing the 25 second count.

**R E.** Conduct a thorough meeting outlining individual and crew duties, (A pre-game conference guide is included at the end of this manual as a tool to help prepare for and deliver a pre-game conference.) The purpose of a pre-game conference is to prepare the crew mentally. It is important to solidify the thinking of officials in regard to procedures, rules and interpretations and enforcement. Referees will vary their approach to a pre-game conference, but the value of organizing and unifying the techniques to be employed in a game cannot be overemphasized. No unauthorized visitors shall be allowed in the area during this important session.

**B F.** Instruct clock operators. (See Section 7)

**R, U G.** In full uniform, visit each dressing room (home team first) one hour and fifteen minutes before kickoff. **U** inspects player equipment, braces, bandages, tape, etc. **U** should record numbers of players with illegal equipment and recheck when players come onto the field. **R** checks official time and confirms starting time with each head coach or designated representative. Remind head coach of equipment rule requirements and his certification that all players are equipped according to rule, and review any unusual game situations, extensions of half-time, etc.

Additionally, the **R** may ask each Coach for insights on: scrimmage play formations, free kick formations, return formations, etc.

*Note: If coaches or teams are unavailable at 1:15:00, conduct above conference a minimum of 45 minutes prior to kickoff.*

**ALL H.** Leave the dressing room together at least 20 minutes prior to kickoff.

#### **SECTION 4. PRE-GAME DUTIES ON FIELD**

Copyright © 2009 by Texas Association of Sports Officials, Inc *All rights reserved*

No part of this publication may be reproduced, stored in a retrieval system or transmitted in any form or by any means, electronic, mechanical, photocopying, recording or otherwise, without the prior written permission of the publisher.

## **ARTICLE 1. PROCEDURES**

**ALL A.** Anytime players of both teams are on the field, up to 30 minutes prior to the scheduled game time, at least one official shall be present on the field.

**ALL B.** Arrive on the field as a unit, no later than 15 minutes before scheduled game time; sooner if duties require.

**C.** Note location of press box, team areas and benches. Check identities of team trainers and game administrator(s).

**R, L D.** Inspect entire field. Observe any unusual markings or serious irregularities and advise other officials. Take measures to remedy or remove any hazards from within or near the boundary lines, requesting assistance from management and from other officials as necessary.

**ALL E.** Spot check player equipment, pads, braces, pants, shirts, bandages, tapes, etc and have the teams' trainer(s) make any needed corrections.

**R, U F.** Arrange with captain of the team whose bench is on your sideline to meet you in the room or at the 50 yard line, on his sideline, 4 minutes before game time.

**H G.** Organize your assistants, locate yardage chain and down marker and have assistants ready with all equipment on the sideline opposite the press box. Check the chain for kinks, knots and weak spots. Check chain against 10-yard measure on the field. Check chain for tape marker at mid-point.

**H H.** Instruct your assistants to:

1. Set down marker, rods and clip where indicated by you. Position ground markers adjacent to sideline. Box man places down marker on sideline where indicated. Chains are then set on sideline and clip attached on side of yard line closest to rear chain rod. When chains are set, box man retreats six feet and establishes spot where chains are to be reset after clip has been attached. On touchback situations set front stake on the 30 yard line and stretch chain back toward the 20 yard line.

Emphasize that your assistants should move only at your direction and to move quickly when such a move is indicated.

*NOTE: Be prepared to give complete and thorough instructions to assistants if a different line to gain device is to be used in the game.*

1. See that the chain is taut and not kinked.
2. Make no remarks to players, nor express opinions concerning any ruling.
3. Never move down markers, chains or change the number of the down unless so directed by the **H**.
4. Remove themselves and all equipment outside the limit line for free kicks.
5. Chains are laid down and only the down marker is used when a first down is declared inside the 10-yard line.
6. If threatened by a player(s) coming to the sideline, the crew should drop the yardage markers and retreat for their own safety and well-being.

Copyright © 2009 by Texas Association of Sports Officials, Inc *All rights reserved*

No part of this publication may be reproduced, stored in a retrieval system or transmitted in any form or by any means, electronic, mechanical, photocopying, recording or otherwise, without the prior written permission of the publisher.

**B J.** Be sure the game balls are available and instruct ball retrievers on game duties. **H** and **L** will participate in instructing ball retrievers on their side. Ball persons shall not enter the field unless requested by the officials.

**ALL K.** After completing pre-game duties, retire to benches. **R, H** and **B** opposite the press box, **U** and **L** to press box side.

**R, U L.** Bring the captain(s) to the 50 yard line on the sideline at their team area four minutes before game time.

**L, B M.** Responsible to have the team on your side of the field prior to game time.

**SECTION 5. TOSS**

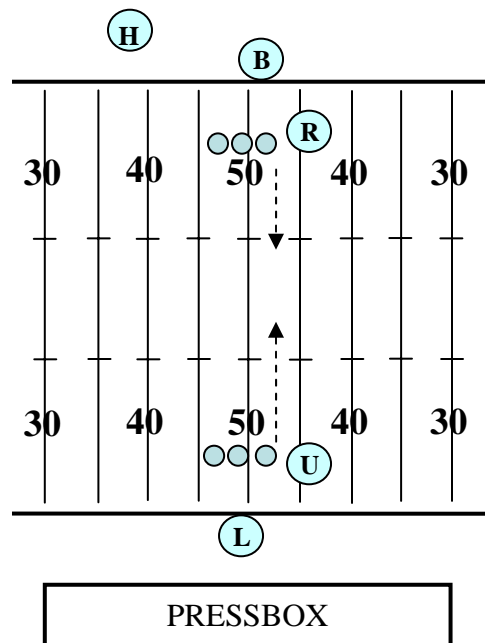

**ARTICLE 1. PROCEDURES**

**R, U A.** **R** and **U** will escort their Captains to the center of the field and be ready to perform the toss three (3) minutes prior to scheduled kick off.

**L, B B.** After captain(s) are escorted to the center of the field, take a position at the 9 yard marks. **DO NOT ALLOW TEAM MEMBERS WHO ARE NOT INVOLVED IN THE TOSS INSIDE THE 9-YARD MARKS ON YOUR SIDE.** If team members do not approach the 9-yard marks, return to the team area. Stay between the team and the 9-yard marks.

**C.** Have the game ball from the team on your side until the winner of the toss is determined.

**H D.** **H** will remain on the sideline.

Copyright © 2009 by Texas Association of Sports Officials, Inc *All rights reserved*

No part of this publication may be reproduced, stored in a retrieval system or transmitted in any form or by any means, electronic, mechanical, photocopying, recording or otherwise, without the prior written permission of the publisher.

**R** E. Introduce yourself to the captains on your sideline.

**U** F. Introduce your captain(s) to **R**, and remain with the **R** to witness toss and verify choices.

## ARTICLE 2. TOSS

**R** 1. Introduce captains to one another.

2. Advise captains of any irregularities in timing or special ground rules.

3. Have captains face each other with their backs to the sidelines. Ask visiting captain to call the toss. Ask the home captain to repeat what the visiting captain called. If either captain, or **R** or **U** disagrees, seek clarification BEFORE making the toss. **R** shall catch the toss.

4. Indicate winning captain by placing your hand on his shoulder. Explain and obtain his option. Explain loser's options and obtain his choice. If the winning captain waives or defers the choice, the Referee will:

- Indicate the winner of the toss by placing his hand on that captain's shoulder;
- Step clear of captains, turn to the press box and signal, "choice declined" (#10);
- And, subsequently request first choice from the opposing captain.
- Present remaining options to the other captain.

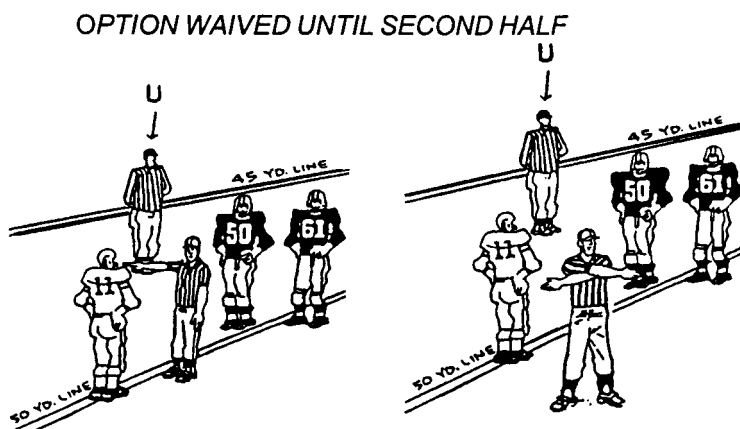

*When captain elects second half option, **R** should step clear of captains and clearly indicate with signal #10 that the captain has deferred their choice to the second half.*

*Following this signal the **R** will give other captain the option and continue usual coin toss procedure.*

5. Face press box, place captains in position facing each other with backs to the goal which they will defend.

6. Signal choice of choosing captain by swinging leg simulating a kick or make a catching motion while facing the same direction as the winning captain. If choosing captain elects to defend a goal, point with both arms extended toward the goal line and then give an appropriate signal for the choice of the other captain

7. Start the game at scheduled time.

Copyright © 2009 by Texas Association of Sports Officials, Inc *All rights reserved*

No part of this publication may be reproduced, stored in a retrieval system or transmitted in any form or by any means, electronic, mechanical, photocopying, recording or otherwise, without the prior written permission of the publisher.

**ALL A.** When toss is completed, other officials will join the **R** and **U** and make a written record of the toss results. Move to kickoff positions simultaneously.

**L, R, B, H B.** When moving to your kickoff position, go directly to your sideline and move teams and coaches back to clear the sideline before going to your kickoff position.

## **SECTION 6. GENERAL GAME DUTIES**

### **ARTICLE 1. SUBSTITUTIONS AND COUNTING PLAYERS**

**ALL A.** All officials are responsible for legality of substitutions. The **U** and **R** are responsible for the correct number of players on the offensive team. **B** is responsible for the correct number of players on the defensive team. **H** and **L** have responsibility for the correct number of players on the field whose team is on their respective sidelines.

**ALL B.** On free kicks, **U & B** are responsible for the number of players on the kicking team.

**R, L, & H** count the players on the receiving team.

**ALL C.** The first signal will be used when the team you are counting has 11 or fewer players on the field.

### **ARTICLE 2. OTHER GENERAL GAME DUTIES**

**ALL A.** Make written record of charged time-outs and fouls you call. The position of ball at end of first and third periods, including down and distance, is the responsibility of the **R, H** and **U. B** is responsible for recording elapsed time and making certain the status of the clock is correct.

**B.** Convey any message you have for other officials promptly. Avoid any position that suggests a huddle of officials, unless necessary.

**C.** Be alert for players being out of bounds before a snap or free kick.

**D.** Watch for fouls, being certain to know:

1. Spot where run or scrimmage kick ended.
2. Spot of foul, position or number of offending player.
3. Whether, ball was loose, in possession or dead when the foul occurred.
4. If the clock is stopped.
5. Know if Team B's foul occurred within 3 yards of neutral zone on scrimmage kicks.

**E.** Be ready for any type of play or unusual development. Always be prepared to rule on fumbles, illegal forward passes, and know which team possessed a fumble or backward pass before it went out of bounds between goal lines. On recovered fumbles, the official nearest to the recovery must rule on possession and promptly award the ball to the recovering team with a signal.

**F.** Be alert to rule on a dead ball behind a goal line. Indicate ruling by prompt signal.

**G.** Signal time-out when the rules provide for stopping the clock or when time-out is charged to a team or to the **R**. Repeat time-out signal of other officials.

Copyright © 2009 by Texas Association of Sports Officials, Inc *All rights reserved*

No part of this publication may be reproduced, stored in a retrieval system or transmitted in any form or by any means, electronic, mechanical, photocopying, recording or otherwise, without the prior written permission of the publisher.

H. A “winding” signal may be used when the ball becomes dead close to the sideline and the covering official rules that the ball remained inbounds. If an obvious first down has been made by Team A, the clock shall then be stopped.

I. Indicate, by touchdown signal, when the ball is legally in possession of a player on or behind his opponent’s goal line. **R** check for any foul which might affect the ruling, if none, then relay the touchdown signal to the Press Box.

J. Check for false starts and feints.

K. Leave no doubt in the minds of players or other officials, as to any ruling you make.

L. Be especially alert for acts of misconduct.

### **ARTICLE 3. PRE-SNAP DUTIES**

A. Before each play, each official should work through their individual pre-snap duties. These duties include knowing the down and distance on each and every play. Additionally, individual officials are responsible for specific pre-snap duties that include, but are not limited to:

- R** 1. Count offense, signaling U with 11 or less.
- 2. Ensure the Defense has the opportunity to adjust to a substitution by the offense.
- 3. Identify tackle as initial key for blocking.
- 4. Identify backs or receivers that are outside of the tackle box, thus they cannot come back towards the ball and block below the waist.
- 5. Identify any numbering issues in the backfield, e.g. player in a 50-79 jersey that cannot be eligible for a pass.
- 6. Establish position a position 12 to 14 yards deep and outside the shoulder of tight end (or normal position of the tight end).

- U** 1. Cover the ball to prevent a snap prior to the ball being declared ready
- 2. Ensure the Defense has the opportunity to adjust to a substitution by the offense.
- 3. Count offense, signaling R with 11 or less
- 4. Ensure five lineman numbered 50-79 are present and on the LOS (exception for Scrimmage Kick Formation).
- 5. Identify formation and strengths, lining up in a position to see the snap.
- 6. Take a position 5 to 7 yards from the ball, clear of Team B players.

- H** 1. Ensure the correct down is on the down indicator.
- 2. Count the team on your sideline (offense or defense). If team on your sideline is on defense, signal B using closed fist for 11 or less players.
- 3. Identify the eligible receivers and keys on your side of the football by number.
- 4. Identify if you have an unbalanced (more or less than three) line, signal the L.
- 5. Rule on the eligibility of the lineman on your side of the football.
- 6. Take a position on the line of scrimmage either on or just off the sideline.

- L** 1. Ensure the correct down is on the down indicator and know the status of the clock.

Copyright © 2009 by Texas Association of Sports Officials, Inc *All rights reserved*

No part of this publication may be reproduced, stored in a retrieval system or transmitted in any form or by any means, electronic, mechanical, photocopying, recording or otherwise, without the prior written permission of the publisher.

2. Count the team on your sideline (offense or defense). If team on your sideline is on defense, signal B using closed fist for 11 or less players.
3. Identify the eligible receivers and keys on your side of the football by number.
4. Identify if you have an unbalanced (more or less than three) line, signal the H.
5. Rule on the eligibility of the lineman on your side of the football.
6. Take a position on the line of scrimmage either on or just off the sideline.

- B.**
1. Know clock status and ensure the play count is started appropriately.
  2. Count the defensive team and signal the H or L as appropriate.
  3. Identify the receivers and strength of the formation based on your keys.
  4. Take a position approximately 20-25 yards from the line of scrimmage.

**B.** Before the ball is put in play, adjust position as necessary to ensure you can clearly see your key and area of responsibility. There can be no excuse for failing to be in a good officiating position before the ball is put in play.

**R C.** The **R** should move to the appropriate position where he can observe the offensive huddle. He should then check the down and distance with the **H** and announce and indicate the new down. **R** should then declare the ball ready for play, usually within three seconds, by sounding his whistle and giving ready signal (or wind the clock). **R** should only go to the line of scrimmage for non-routine events, close measurement, etc. **R** must consistently mark the ball ready for play when the game officials are in position to officiate. Under unusual circumstances this pace of the game may vary and require discretionary slowing or speeding up action by the **R**.

**C.** If, by rule, the clock should be started after Team A is awarded a first down, **R** will declare the ball ready for play by starting the clock when the point of the new series of downs has been established by **H** and other officials are ready to resume play.

**D.** If, by rule, the clock should be started following a penalty, **R** will declare the ball ready for play by starting the clock when certain the players and officials are ready to resume play.

**R E.** Upon assuming position for the next down:

1. Recheck number of downs with other officials, showing numbers of fingers, closed fist indicates fourth down.
2. Assume the position where you can see the ball and the offensive tackle on your side of the ball at the snap.
3. Checking legality of backfield formation and one second stop following shift or huddle.
4. Know which backs are eligible to touch a forward pass. On spread formations you are responsible for backfield group directly behind the ball as to illegal motion and eligibility.
5. Check blocking behind the line after the snap. Be alert for pass thrown toward you. Do not pursue the ball too closely. You are responsible for the ball and runner behind the line of scrimmage. When the runner crosses the line of scrimmage, he will be the responsibility of the wing officials and subsequently the downfield officials. Be alert to the play behind the ball.
6. Unless in position to determine that ball is legally in possession on or behind opponent's goal line, check for fouls by other officials before giving touchdown signal, signal time-out and proceed as usual.
7. Responsible for official score.

Copyright © 2009 by Texas Association of Sports Officials, Inc *All rights reserved*

No part of this publication may be reproduced, stored in a retrieval system or transmitted in any form or by any means, electronic, mechanical, photocopying, recording or otherwise, without the prior written permission of the publisher.

**U F.** If **R** omits ready signal, remind him immediately.

**G.** Observe ineligible on the scrimmage line. Determine in pre-game conference sharing this responsibility with **H** and **L**. You are primarily responsible for detecting any illegal advance on forward passes.

**H.** Take position to observe ball at snap.

**I.** When the offensive team is attempting to run a hurry-up play, after the ball is spotted, **U** will inform both teams simultaneously, that the ball may not be snapped until the whistle is sounded. **U** will stand over the ball until **R** has backed away from the neutral zone and then indicates the **U** to move in position. As soon as **U** is clear of the neutral zone and in position to officiate, **R** will declare the ball ready for play (or wind the clock) and simultaneously sound his whistle.

**J.** Assume primary responsibility for determining the legality of defensive signals.

**K.** Primarily responsible for lateral placement of the ball at the previous spot after an incomplete pass, penalty, etc.

**H L.** Check down marker for correct number and indicate placement to assistant. Be sure there are no fouls or other reasons for holding spot of previous down before signaling the assistant.

**M.** Signal number of each down by holding one arm aloft with correct number indicated by extending fingers. Closed fist indicates fourth down.

**N.** Anticipate any call for measurement and be on sideline ready to bring chain when signaled by **R**.

**O.** Each time a new line to gain is established, personally mark the spot on the sideline where the down indicator is to be set and be sure that it is set correctly and then moved off sideline.

**P.** When a first down is awarded inside the 10-yard line, only the down indicator will be used. The chain crew will ensure the down indicator is returned to the proper spot if forced to move.

**H, L Q.** Be alert for all possible pass receivers. Know and observe the eligible receivers on your side of the field. Each is responsible for players who spread to his side of the field. Make certain that all players are boxed in at the snap and that all offensive players have complied with the 9-yard mark restrictions. Stay wide as you mark progress with downfield out thrust foot (unobtrusively, not making a production out of it.) Do not jump over players. If necessary, come into the field as far as you can. Hold spot with foot until you are sure **U** or other official has spot.

**R.** Be aware of the importance of assisting **R** in marking forward progress behind the neutral zone, particularly when goal line is involved.

Copyright © 2009 by Texas Association of Sports Officials, Inc *All rights reserved*

No part of this publication may be reproduced, stored in a retrieval system or transmitted in any form or by any means, electronic, mechanical, photocopying, recording or otherwise, without the prior written permission of the publisher.

S. Check for encroachment, offside and other scrimmage infractions. Assist **U** on legality of numbers of interior offensive linemen on split or wide formations.

T. Check for backs or linemen illegally in motion. Check backs moving away from you for illegal motion and flankers on your side for one second stop after the huddle.

U. Be alert for illegal blocks by players spread to your side more than 7-yards from the offensive middle linemen and by backs outside the normal tackle position.

V. Be certain that the entire offensive team observes the one second shift requirement.

**B W.** Be alert for all pass receivers, both eligible and ineligible by number and rule. Give attention to play on ends moving off the line of scrimmage and to continuing action downfield as well as play near the sidelines and out of bounds. Be aware of offensive players having complied with the 9-yard mark restrictions.

**R, U X.** Determine the legality of each ball before it is put in play for each down.

**ALL Y.** Before free kick or snap which starts any period, complete all prescribed duties.

## **SECTION 7. TIMING**

### **ARTICLE 1. GAME TIMING**

#### **B A. General**

1. All game timing is under the direction of the **B**. He is primarily responsible for recording elapsed time and making certain the status of the game clock is correct.

2. All time intervals, team time-outs, between periods and half time are the responsibility of the **B**, unless specific governing authority policy requires a different game official assume the responsibility for a media (radio/TV) time-out.

#### **B. Pre-Game**

1. Make certain you have correct time. Other officials will check their watches with yours. Confirm starting time with home management and arrange for punctual arrival of officials on field. Have stop watch (or watches) ready if necessary.

2. Playing time shall be kept with a game clock which may be either a stop watch operated by the **B** or a field clock operated under the direction of the **B**.

3. When a clock operator is assigned and a field clock is official, be certain that clock equipment is in good condition. Arrange for relaying information and for signaling the operator.

**R, B 4.** The game and play clock operators will report to the **R/B** prior to the game. They will be instructed:

a. Clock operators should report to the official's dressing room at the stadium 60 minutes before game time to synchronize timer's watch with official game time as established by the

Copyright © 2009 by Texas Association of Sports Officials, Inc *All rights reserved*

No part of this publication may be reproduced, stored in a retrieval system or transmitted in any form or by any means, electronic, mechanical, photocopying, recording or otherwise, without the prior written permission of the publisher.

**B.** If the clock operator does not visit the dressing room, it is advisable to attempt to discuss timing procedures with the individual.

b. To advise officials as to the location of the clock operator in the press box or on the sideline, and to determine procedure for communications with timer and check this procedure preceding game,

c. To discuss coordination of starting and stopping the clock in accordance with the playing rules.

**R** d. The field clock is to start 30 minutes before game time and will run during the 20 (28 in UIL) minutes of half-time intermission. The 20 (28 in UIL) minutes of half-time will start when the players and coaches leave the field. **R** will give the “start the clock” signal from the end zone. All pre-game and halftime activities will be synchronized with the official game clock.

e. Should the field clock become inoperative, the public address announcer will indicate to the crowd that the field clock will not be official until the malfunction is corrected and subsequent announcement made over the P.A. system. The **B** will alert the teams concerning remaining time as often as possible.

### C. Game Procedures for Officials and Timers

#### **TIMER**

The clock operator is an integral member of the officiating crew and game administration. Unfair advantages accrue when the game clock is not started or stopped promptly. Great care must be exercised to see that no time lag occurs in starting or stopping the clock.

1. On all free kicks, start the clock when the ball is legally touched in the field of play, unless the ball is caught or recovered by a player who is legally down. In this case, the clock will not start. The nearest official(s) will signal the legal touching of the ball by indicating that the clock should start. The clock will start when the ball crosses the goal line after being first touched by the receivers in the end zone. Usually, this will occur when a receiver carries the ball out of the end zone. It could occur on a muff or fumble, however. In any case, the **R** will be indicating that the clock should start.

2. Under NCAA football playing rules the official who declares the ball dead will be the first official to signal a time-out when the team in possession of the ball meets the requirements for first down. Key on that official as the clock will usually stop on long yardage plays.

3. Any official may signal a team time-out, so be alert to stop the clock.

4. The clock is not to be stopped on plays near a boundary line unless an official so signals. Many times the ball goes out of bounds after having been declared dead in the field of play and no time-out legally occurs. If a pass is touched or caught out of bounds, the incompleteness signal will stop the clock.

*Note: On some plays near the sideline and in advance of the line to gain, an official may give a winding signal to indicate the ball is inbounds and follow it by a stop the clock signal for an apparent first down. Be alert for both signals.*

Copyright © 2009 by Texas Association of Sports Officials, Inc All rights reserved

No part of this publication may be reproduced, stored in a retrieval system or transmitted in any form or by any means, electronic, mechanical, photocopying, recording or otherwise, without the prior written permission of the publisher.

5. Game officials and clock operators are to be sure that a time-out is indicated and the clock is stopped under the following circumstances:
  - a. Whenever a team or an official's time-out is charged.
  - b. After any score.
  - c. When a live ball goes out of bounds.
  - d. On a penalty.
  - e. When either team is awarded a first down.
  - f. Following an incomplete pass.

6. After the clock has been stopped, it will be started again on the **R**'s (wearing the white cap) "Start the Clock" signal, or if no such signal is given, the game clock will be started on the snap or legal touching of a free kick. (See #1)

7. In case of a pile-up anywhere on the field, be alert, an official may stop the clock until the congestion is over. The **R** then may start the clock again before the ready for play signal.

8. The game clock should not be stopped if the play clock is started in error.

9. When time for half expires, start the field clock on **R**'s signal when field is cleared of players and officials.

10. The **B** shall always be aware of the condition of the clock and the time remaining in any period. In the event the clock is running when it should be stopped, the **B** shall make and repeat the appropriate signal until the clock has been corrected (only **R** shall start the clock on the ready for play). If appreciable error is noted, or if inefficiency is habitual, the **B** shall call a time-out and advise the **R**. Officials will review these procedures with the timer before the game.

**B, U 11.** The **B** and **U** will keep the **R** informed of the time remaining in each period. Either official or the **R** will sound the whistle if time expires before the snap or advise the **R** at the end of the down if time expired while the ball was in play.

**R 12.** When the period ends, the **R** will so indicate by holding a ball overhead with one hand and arm extended.

13. Timing errors on the game clock, or by an official may be corrected by the **R**. Exact information as to the timing error must be available from either the clock operator or game officials. These timing errors may only be corrected in the period in which they occur.

## **ARTICLE 2. TIME OUT**

### **A. Charged Team Time-Out**

1. The time-out interval will be timed on the field by the **B**. When one minute has expired (or when both teams indicate readiness to resume before that time), notify the **R**.

### **B B. Intermission Between Periods**

1. The one-minute interval between quarters will be timed on the field by the **B**. If a media time-out is being utilized, governing authority policy may assign a different official to this duty.

Copyright © 2009 by Texas Association of Sports Officials, Inc *All rights reserved*

No part of this publication may be reproduced, stored in a retrieval system or transmitted in any form or by any means, electronic, mechanical, photocopying, recording or otherwise, without the prior written permission of the publisher.

C. Intermission Between Halves

1. When time for the half expires, start the clock on the **R**'s signal when field is cleared of players and officials.

**ARTICLE 3. PLAY (25-SECOND) CLOCK**

A. General

1. All timing involving the play count is under the direct supervision of the **B**.

2. When play field clocks are available, they are the official delay of game time piece. The assigned play clock operator will work under the supervision of the **B**.

B. Pre-Game: The play clock operator should report to the **R/B** 60 minutes prior to the game. If the play clock operator does not visit the dressing room, it is advisable to attempt to discuss timing procedures with the individual.

He will be instructed:

1. To set the displays to plays.

2. To start the clocks on the **R**'s ready for play signal.

3. To leave the displays at 00 seconds if there is a delay of game penalty.

4. To reset the displays immediately to plays when the ball is put in play if there is no delay foul.

5. To reset the displays at plays anytime the **R** interrupts the play count.

6. That if there is a malfunction, both clocks will be turned off until the problem is corrected. Both coaches will be notified if the field play clock is no longer official. The play count will then be restarted at plays with the **B** manually timing the count on his watch.

7. That with less than plays remaining in any period and the game clock running, the play clock shall not run.

8. That if the play clock is stopped for crowd noise delay, it will not be started when the ball is next ready for play.

*NOTE: If the play clock is erroneously started, it shall be stopped immediately.*

C. Duties Before Each Play

**B** 1. Observe the start of the play clock with the **R**'s ready signal.

2. Check time consumed in snapping and free kicking the ball and call play infractions. Stadium clock located at each end of the field operated under the supervision of **B** will officially time the play count. In obvious field goal and scrimmage kick situations or when there is no field play clock, the **R** may assume responsibility for the count.

**B** 3. If visual clocks become inoperative, raise one arm straight overhead during the last 10-seconds.

**SECTION 8. USE OF BEAN BAGS**

**ARTICLE 1. USE OF BEAN BAG - CAP MECHANICS**

A. The bean bag will be dropped on the approximate yard line. (Herein after referred to as "spot".) **DO NOT THROW THE BEAN BAG!**

B. The bean bag (or cap) will be dropped to mark the appropriate spot:

Copyright © 2009 by Texas Association of Sports Officials, Inc *All rights reserved*

No part of this publication may be reproduced, stored in a retrieval system or transmitted in any form or by any means, electronic, mechanical, photocopying, recording or otherwise, without the prior written permission of the publisher.

1. When a scrimmage kick ends inbounds. (This marks the Post Scrimmage Kick enforcement spot. Normally only one official will mark this spot with his bean bag.)
2. When the covering official actually sees a live ball fumble anywhere on the field.  
SEE THE BALL FUMBLED, NOT MERELY LOOSE!
3. When a hand-off or backward pass occurs beyond the neutral zone or when there is no neutral zone.
4. Drop cap when an eligible Team A pass receiver voluntarily goes out of bounds.
5. Drop cap when an eligible receiver fails to return inbounds immediately after being blocked out of bounds.
6. Drop cap when a Team A player goes out of bounds during a free or scrimmage kick down.
7. Drop beanbag when a Team A player illegally touches a free or scrimmage kick.
8. Drop beanbag when a Team B player intercepts a forward pass, fumble or backward pass between his five yard line and the goal line.
9. Drop beanbag when a Team B player catches a free or scrimmage kick between his five yard line and the goal line.
10. Use beanbag when necessary to mark forward progress when the runner/passers is driven back

## **SECTION 9. BALL HANDLING**

### **ARTICLE 1. UIL GAME BALL AND BALL PERSON POLICIES**

The following is excerpted from the UIL Manual / Football Plan:

**Game Balls and Ball Persons:** The home team should provide a minimum of three legal game balls, and the visiting team, if it desires to use its own game balls, should also provide a minimum of three legal game balls.

Each team shall provide a minimum of two Ball Persons (preferably age 12 or older).

Officials will work with the Ball Persons as assigned by the school(s) knowing that assistance is a luxury. When the Ball Persons are so unsatisfactory that they disrupt the ball game or interfere with the officials' ability to properly carry out their duties, the crew should make certain that **R** is aware. **R** will inform the Chapter Secretary who will determine the appropriate course of action.

### **ARTICLE 2. APPROVAL OF GAME BALLS**

**R A.** Prior to game, test, certify, and mark game balls from home team and, if they elect to use their own game balls, test, certify and mark game balls from the visiting team

Copyright © 2009 by Texas Association of Sports Officials, Inc *All rights reserved*

No part of this publication may be reproduced, stored in a retrieval system or transmitted in any form or by any means, electronic, mechanical, photocopying, recording or otherwise, without the prior written permission of the publisher.

**B** B. Assist **R** in testing game balls; if air pressure in balls is incorrect, adjust as necessary. If balls are received prior to arrival on field for pre-game duties, take over from **R**. Otherwise, ensure Ball Persons have game balls and are ready prior to coin toss.

**ARTICLE 3. BALL PERSONS**

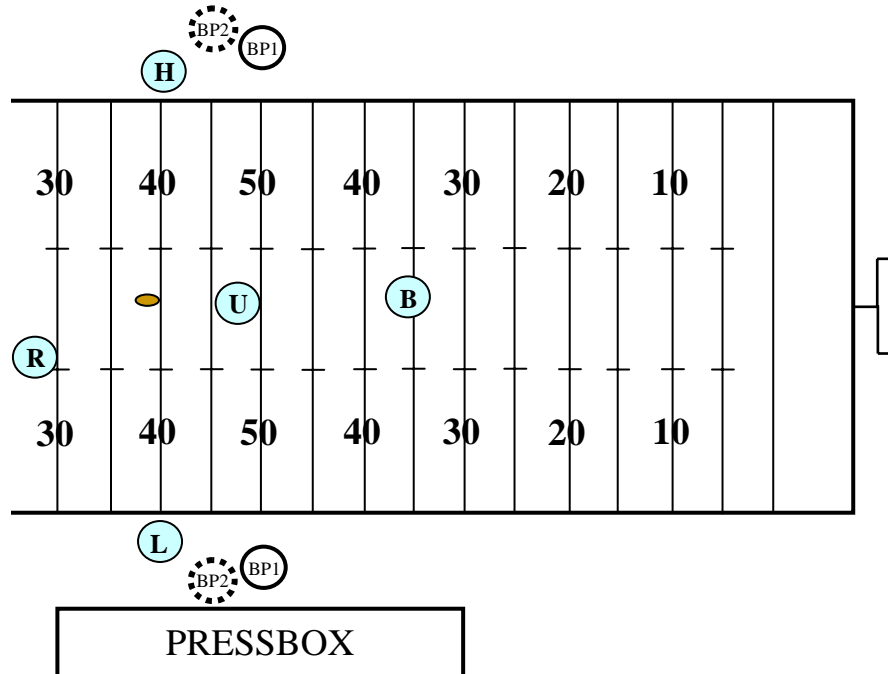

**SCRIMMAGE PLAYS (Ball Handling)**

**B, L, H** A. Meet and instruct Ball Persons during on-field pre-game period.

Ball persons are to remain outside field of play at all times, and be at least six feet off sideline unless relaying replacement ball or retrieving ball that has been replaced.

*Note: Game officials are solely responsible for transferring replacement ball to **U** for placement at the succeeding spot; Ball Persons are to remain off the field unless directed to retrieve a ball that has been replaced.*

Ball persons should be instructed to remain alert to relay a game ball in regardless of the situation.

Ball persons should be instructed to pay attention to the official on his/her sideline.

Ball persons should be instructed to retain a towel for drying the ball.

Priority is always to get a replacement ball into the game; placing a ball at the foot of the official with forward progress must never delay getting the correct replacement ball into the game.

Copyright © 2009 by Texas Association of Sports Officials, Inc *All rights reserved*

No part of this publication may be reproduced, stored in a retrieval system or transmitted in any form or by any means, electronic, mechanical, photocopying, recording or otherwise, without the prior written permission of the publisher.

For Field Goal attempts and Tries, Ball Persons are to be positioned at the Team A 10-yard line. *Do not place replacement ball by goal post.* Immediately following play, relay replacement ball to nearest official, then retrieve ball being replaced.

#### **ARTICLE 4. GENERAL BALL HANDLING**

A. RELAYING BALL – Relaying or transferring of ball should be done quickly and efficiently, with as few exchanges as possible.

B. TOSSING BALL – All tosses shall be underhand, with a spiraling motion, and on a generally flat trajectory to chest level of person receiving ball. Do not toss ball over players. A crew proficient in ball handling will not allow ball to fall to ground while handling and transferring it.

C. START OF EACH HALF OR EXTRA PERIOD – **L** and **B** are responsible to get the correct ball to the **U** to begin the second half or subsequent extra periods.

D. SPOTTING BALL – Spotting the ball for the succeeding down should be done with one placement. The official that spots ball should do so as quickly as practical, yet assuring ball is placed correctly when first spotted. However, any official that has positive knowledge that ball is not spotted correctly should take necessary measures, including stopping clock, to get ball located correctly.

An effective crew of TASO officials will be expected to monitor the dead-ball action of the players while retrieving and placing the ball for the succeeding play. To provide better dead-ball coverage and better player safety, **R**, **B** and **H/L** (when away from dead-ball spot) will focus more of their attention on the action of the players than on retrieving the dead-ball. While this represents a shift from traditional ball mechanics, the increased emphasis on player safety demand an approach based on effective coverage as well as efficiency.

The **U** will retrieve and spot the ball in most situations, particularly when the play ends between the nine-yard marks. There will be many situations when **U** goes outside the hash marks to retrieve the ball. In situations where **U** retrieves a ball outside the nine-yard marks, **R** will move to the hash mark and receive a toss from **U** to spot the ball (unless he is occupied with another matter).

When **U** relays the ball to **R**, the **U** should move into position for the next play. The **U** will not go to the succeeding spot unless Team A is in a “hurry up” or “no huddle” offense.

E. When the ball is dead and between the nine-yard marks:

Generally, **U** will retrieve the ball used on the previous play and place the ball at the appropriate spot. Nearby officials may be in a position to assist if doing so does not take them away from marking the dead ball spot or observing dead-ball actions of the players.

**U** 1. When there is no further threat of foul, move to retrieve ball and place at the succeeding spot. The **U** must be prepared to retrieve and spot any ball that is between the nine-yard marks.

**R** 2. When there is no further threat of foul, and conditions permit, move to assist with retrieving the ball and delivering to **U** to place at succeeding spot

Copyright © 2009 by Texas Association of Sports Officials, Inc *All rights reserved*

No part of this publication may be reproduced, stored in a retrieval system or transmitted in any form or by any means, electronic, mechanical, photocopying, recording or otherwise, without the prior written permission of the publisher.

**B 3.** Maintain depth and monitor players away from the ball. **B** will only rarely be involved in retrieving the ball, except in situations where an incomplete pass is in his proximity.

**H L 4.** Indicate the dead-ball spot and mark with the downfield foot. Eyes should not be looking at the dead-ball spot, rather, should be up and looking for illegal action by the players. Be prepared to assist **U** in retrieving the ball. Observe the proper placement of the ball at the succeeding spot.

F. When ball is dead outside the nine-yard marks, or out of bounds:

Generally, a replacement ball will be used on plays that end outside the nine-yard marks on Team A's sideline. When the ball becomes dead outside the nine-yard marks on Team B's sideline, the ball from the previous play will be retrieved and placed at the succeeding spot.

Generally, **U** will retrieve the new ball and relay to **R** who will place the ball at the inbounds spot. On long plays (more than 10-12 yards) **B** must be prepared to assist in relaying the ball to **U**.

**U 1.** Move to an open area between the inbounds line and the nine-yard marks, several yards deeper than the end of the play. When there is no further threat of foul, retrieve the replacement ball and relay to **R** who will spot the replacement ball.

**R 2** When ball is dead following a play that ends outside the nine-yard marks, and there is no further threat of foul, move to the inbounds spot and receive the relay from **U**.

**B 3.** Maintain depth to observe dead-ball and off-ball action of players. Following plays that gain more than 10-12 yards, be prepared to assist in retrieving the ball and relay to **U**.

**H L 4.** Indicate the dead-ball spot and mark with the downfield foot. Eyes should not be looking at the dead-ball spot, rather, should be up and looking for illegal action by the players. Be prepared to assist **U** in retrieving the ball or obtaining a ball from the Ball person. Observe the proper placement of the ball at the succeeding spot.

G. When a forward pass is incomplete:

**H L 1.** If pass falls in such a manner that it can easily be re-used, when there is no further threat of a foul, retrieve the and relay to **U**. If the pass falls in such a manner that is cannot easily be re-used, the flank official on Team A's side will obtain a new ball from the Ball Person.

**U 2.** If pass falls in such a manner that it can easily be re-used, when there is no further threat of a foul, retrieve the ball and either place at the succeeding spot or relay to **R**. If the pass falls in such a manner that is cannot easily be re-used, the flank official on Team A's side will obtain a new ball from the Ball Person and relay to **U**.

**B 3.** Assist as necessary in getting replaced ball to appropriate Ball Person.

**R 4.** Be prepared to receive a relay from **U** and place at succeeding spot.

Copyright © 2009 by Texas Association of Sports Officials, Inc *All rights reserved*

No part of this publication may be reproduced, stored in a retrieval system or transmitted in any form or by any means, electronic, mechanical, photocopying, recording or otherwise, without the prior written permission of the publisher.

H. Following punt or missed field goal:

**B** 1. When there is no further threat of a foul, secure 'new offense' ball from Ball Person on sideline of team now in possession and relay to **U**. After relaying ball to **U**, assist in getting replaced ball to appropriate Ball Person.

**H L 2.** If you have forward progress and conditions permit, secure ball being replaced or a 'spare' ball from a Ball Person, and place at foot marking forward progress. *This is to be done only if there is no threat of foul by any player, and if it does not distract any official from performing essential duties.* Assist as necessary in getting replaced ball to appropriate Ball Person.

**R** 3. Assist as necessary in getting replaced ball to appropriate Ball Person.

**U** 4. Move to an open area between the inbounds line and the nine-yard marks to sideline of team now in possession; when there is no further threat of foul, permit replacement ball to be relayed to you. Spot 'new offense' ball.

I. When **R** or **U** determines that ball is unfit for play, any official shall obtain a replacement ball from a Ball Person and deliver to **U**.

J. Be alert that only game balls marked by the **R** are submitted for use during the game.

#### **ARTICLE 5. WET WEATHER PROCEDURES**

A. **ADDITIONAL GAME BALLS** – Teams should provide additional game balls for use in games when wet conditions are expected. **R** may test, approve, and mark all such additional balls prior to the game.

B. **PROCEDURES** – Generally the same as for dry conditions, except the wing officials will secure replacement ball from Ball Persons as needed, and relay to **U**, to ensure dry ball (to the extent possible) is spotted for play for the succeeding down.

C. **TOWELS** – **U** should carry a towel to wipe ball dry. After spotting, **U** may cover ball with towel to keep dry. If conditions warrant, **U** may hold ball covered with towel until offense approaches to snap, then spot ball and move to pre-snap position. Other officials may carry towels, if conditions warrant.

D. **BALL PERSONS** – Ball persons should have towels to wipe balls dry, and to keep balls covered. Note: By rule, no ball drying substances may be used.

Copyright © 2009 by Texas Association of Sports Officials, Inc *All rights reserved*

No part of this publication may be reproduced, stored in a retrieval system or transmitted in any form or by any means, electronic, mechanical, photocopying, recording or otherwise, without the prior written permission of the publisher.

## SECTION 10. FREE KICKS

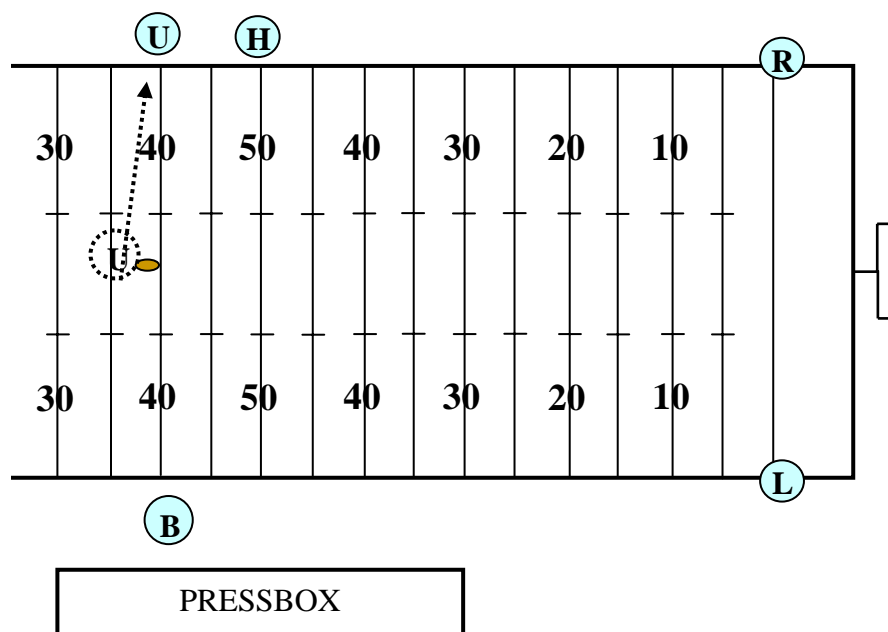

**U** take position in center of field with kicker, give instructions and move to A's restraining line, opposite press box side. **B** is on the press box side on Team A's restraining line. **H** is opposite press box side, on Team B's restraining line. **L** is on press box side at the goal line. **R** is opposite the press box at the goal line.

## ARTICLE 1. KICKOFFS

**B A.** Take position on A's restraining line, press box side. Check sidelines to make sure all non-players are out of the restricted area. Ensure Team A players have complied with the 9-yard mark requirements. When all are ready, indicate by raising and keeping one arm aloft until **R** drops arm and sounds his whistle. Be alert for Team A offside. Count Team A players. Be ready to rule on the legality of the formation at the time of the kick. Following the kick, cover the side line with **L** and key on the three, Team A players on your side, be prepared to cover goal line should the runner break.

**L B.** Take position on press box side at the goal line. Count Team B players. Following the kick, you have the ball carrier if the ball is caught in your zone. Remain with the ball carrier until you release him to another official. If the ball is caught in the Referee's zone, your key is the lead blocker.

**H C.** Take position off the sideline opposite the press box at Team B's restraining line. Count Team B players. Following the kick, cover the side line with **R** and key on the three, Team A players on your side, be prepared to cover goal line should the runner break.

**R D.** Take position off the sideline at the goal line of Team B, opposite the press box. Count Team B players. Following the kick, you have the ball carrier if the ball is caught in your

Copyright © 2009 by Texas Association of Sports Officials, Inc *All rights reserved*

No part of this publication may be reproduced, stored in a retrieval system or transmitted in any form or by any means, electronic, mechanical, photocopying, recording or otherwise, without the prior written permission of the publisher.

zone. Remain with the ball carrier until you release him to another official. If the ball is caught in the **L**'s zone, your key is the lead blocker.

**U E.** Caution the kicker to wait for the signal and whistle. Also caution him not to kick the ball if it falls from the tee.

**U F.** Take position with the kicker, give him instructions and move to A's restraining line, opposite press box side. Count Team A players. Ensure Team A players have complied with the 9-yard mark requirements. When you get to the sideline and turn to face the field, **R** drops arm and sounds his whistle. Be alert for Team A offside. Be ready to rule on the legality of the formation at the time of the kick. Following the kick move toward inbounds line and key on the kicker and the five Team A players in the middle of the formation.

**R G.** Obtain all crew members' ready signals and when the **U** reaches the sideline and turns to face the field, sound your whistle as you give the ready for play signal. Assist **B** to ensure the correct numbers of players are on each side of the kicker when ball is kicked.

**ALL H.** Mark the out of bounds spot, with flag if appropriate, if kick goes out of bounds between goal lines. Maintain position enabling coverage of your sideline at all times. If kicked in your area, cover any muff, advance, or any Team B player who catches or recovers the ball.

**I.** Observe any player who is out of bounds before or during the kick, including Team A players who enter the field after the ball is declared ready for play.

**J.** Observe legality of blocks and action away from the ball when not covering the runner.

**K.** Be alert for short and "pooch" kicks.

**R, L L.** If kick goes deep, retreat to position to observe actions involving the goal line, sideline or end line. **R** will take the ball only if in his side zone. The official who does not have the ball is responsible for action in front of runner. If touchback occurs, move into field of play to stop any late or illegal actions but do not ignore players behind you.

**B, H, U M.** Watch for infractions involving restraining lines. Watch for short kick and whether it is touched or recovered legally or illegally.

**ALL O.** Be alert for fair catch signal and interference with the opportunity to catch a kick.  
*NOTE: Maintain position in front of player attempting to catch the ball. When you do not have the ball, take a position to observe action in your area ahead of the runner.*

**ARTICLE 2. OBVIOUS SHORT FREE KICK BASIC POSITIONS**

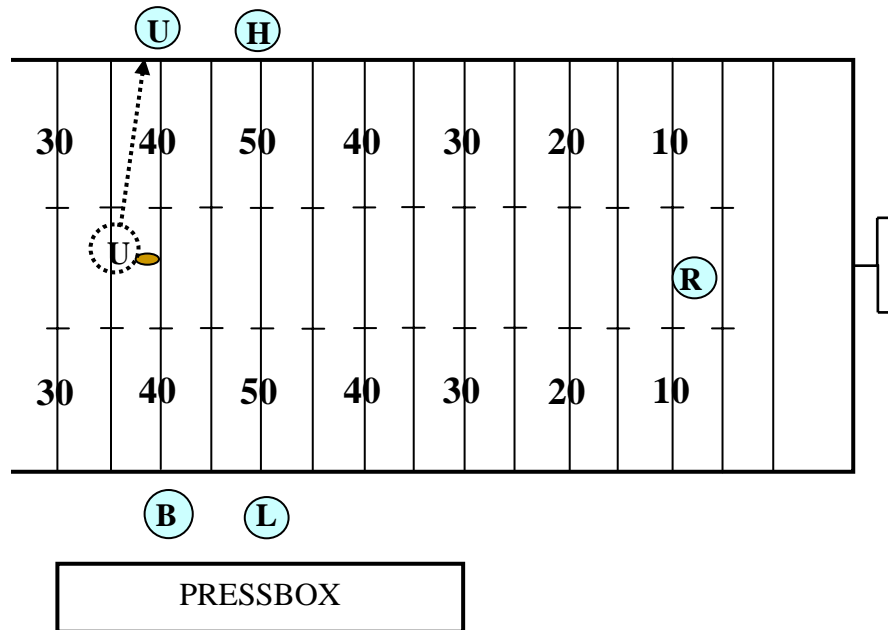

*R will determine when to move into short free kick formations and will move to the center of the field, near the yard line of the deepest receiver. H opposite press box on Team B's restraining line. U with kicker, give instructions to kicker and move to Team A's restraining line opposite press box side. B, Team A's restraining line, press box side. L to Team B restraining line, if kick is long, L will retreat toward Team B's goal line and assume normal responsibility ahead of runner in his area.*

**ARTICLE 3. FREE KICK AFTER SAFETY**

**ALL A.** Assume same relative positions and duties as on kickoff when ball is put in play by place kick, drop kick or punt.

**ARTICLE 4. AFTER TRY OR SUCCESSFUL FIELD GOAL**

**ALL A.** After try or successful field goal, note time.

**U B.** Obtain ball of team which is to kick off. Move up either team's sideline to kicking team's restraining line. When **B** signals the end of the intermission, move to the field and the position of the kicker. Instruct the kicker and move to your kickoff position.

**B C.** Move to the 20-yard line on the press box side along with the **L**. Time the intermission. After 40-seconds, signal the other officials by sounding your whistle in three short, but sharp blasts. **L** and **B** will then move to the appropriate kickoff position.

**R H D.** Move to the 20-yard line opposite the press box. When the **B** signals the intermission has expired, move to your kickoff position.

**SECTION 11. PLAYS FROM SCRIMMAGE**

Copyright © 2009 by Texas Association of Sports Officials, Inc *All rights reserved*

No part of this publication may be reproduced, stored in a retrieval system or transmitted in any form or by any means, electronic, mechanical, photocopying, recording or otherwise, without the prior written permission of the publisher.

## **ARTICLE 1. BASIC POSITIONS**

**ALL A.** Basic positions may vary, depending upon play situations, team formations, the field and weather conditions. Always box in the play. Avoid positions that may cause scrambling to avoid interference with players.

**R B.** Be in a position 12 to 14 yards deep and outside the shoulder of tight end or where he would usually line up on the line of scrimmage, where you may comfortably see the ball and backs except flankers, or a man in motion toward you. Usual position on long or open side of field behind the deepest back or backs, in position to see the snap. May work on the throwing arm side of the quarterback if desired.

**C.** Check the offensive formation and count the offensive players.

**D.** Check the backs and quarterback for illegal motion, the ball at the snap; and assist the **U** if there is movement of restricted linemen.

**U E.** Alignment is variable according to formations of both teams avoiding position that may interfere with players. Adjust distance behind the defensive line according to width of Team A's formation and, except on goal line or try situations be at least five, but seldom more than seven yards deep. When ever possible coordinate your position with that of the **R** for best coverage of interior line play. Read point of attack and your interior linemen. Know the ineligibleibles and where a forward pass first strikes anything.

**H, L F.** In the neutral zone extended and WIDE, stay on or near sideline. Do not setup inside the 9-yard marks on your side. Adjust to the formation. Indicate offensive line of scrimmage by an extended foot, don't exaggerate. Take final position astride the neutral zone. Hand signals shall be used to indicate when the Team A player closest to you, on your side, is off the line of scrimmage. If Team A has an unbalanced line, the flank official who has four (or more) linemen on his side may so indicate by putting his open hand to the side of his face.

**H, L G.** For a snap at your inbounds line, be on or outside the sideline.

**H, L H.** Responsible for legality of motion man whenever he is on your side of the snapper (in any direction), until the snap. DOES NOT RELIEVE OPPOSITE OFFICIAL FROM MAKING OBVIOUS CALL!

**I.** Be aware of the importance of assisting **R** in marking forward progress behind the neutral zone, particularly when goal line is involved.

**B J.** Take position slightly behind deepest defensive back, approximately 20 to 25 yards beyond scrimmage line. Favor the open side or middle of the field. Adjust to flankers and possible receivers. Be on the side of the tight end if only one.

## **ARTICLE 2. DETERMINING KEYS AND GENERAL COVERAGE**

**A.** In providing effective officiating coverage for pass plays, TASO officials will utilize the "**Man, Zone, Ball**" concept.

Copyright © 2009 by Texas Association of Sports Officials, Inc *All rights reserved*

No part of this publication may be reproduced, stored in a retrieval system or transmitted in any form or by any means, electronic, mechanical, photocopying, recording or otherwise, without the prior written permission of the publisher.

At the beginning of each play, the B, the H and the L are in **Man** coverage. Each eligible receiver outside the tackles will be assigned to an official who is responsible for observing the action on (and by) that receiver as he attempts to get into a pass route. It is essential that TASO officials know their keys to the point that they can identify their key instantly. Problems arise when two officials are keying the same receiver and leave another receiver uncovered. Following plays with unusual formations, the officials should check with each other to verify that they each keyed the appropriate receiver.

Prior to the snap, officials will determine the strength to determine their key. They will note their key's jersey number, as well as the jersey number of any defender in "press coverage". During the initial aspect of the play, the goal is to observe the action of the key and any defender in "press coverage".

Once the receivers have gotten off of the Line of Scrimmage and into their pass routes, the officials must switch to **Zone** coverage. If the receivers are not pressed, the officials will switch to **Zone** coverage more quickly. **B** is responsible for any receivers who run deep routes. **H** and **L** are responsible for shorter routes as well as routes in their side zone. **H** and **L** must be aware of routes take **B** deep and must be prepared to adjust their zones accordingly. While in Zone coverage, officials should pay particular attention to Team B players who hold Team A receivers as they are running past them or are making cuts during their route.

Once the pass is in the air, officials will switch to **Ball** coverage. That is to say, they will observe the action of the defenders and the receiver in the area where the ball is thrown. While the official in that zone will be primarily responsible for ruling on interference by either team, an official in another zone may have the only clear look at a foul and may need to throw their flag.

While 5-man mechanics differ significantly from 7-man mechanics in some aspects, the concept of "**Man, Zone, and Ball**" is essential to effective officiating at any level. Skilled TASO officials will know how to begin with the appropriate key in "Man" coverage before shifting to "Zone" coverage in a timely, synchronized manner.

B. In determining keys, the following definitions are needed for clarification purposes:

1. **STRENGTH OF THE FORMATION:** Determined by the number of eligible receivers outside the Offensive Tackles on each side of the offensive formation. If there is no strong side ("balanced formation"), strength is declared to **L's** side.
2. **SNAPSHOT AT THE SNAP:** The position of the receivers is determined by their location, whether set or in motion, when the ball is snapped. It is as if we took a snapshot of the formation when the ball was snapped. This is particularly significant if there is a receiver in motion.
3. **BACK IN BACKFIELD:** A player in the backfield between the tackles at the snap. If he is lined up outside the tackles, we consider him a receiver.
4. **TWINS.** Two receivers outside the offensive tackle on both sides of the formation.

Copyright © 2009 by Texas Association of Sports Officials, Inc *All rights reserved*

No part of this publication may be reproduced, stored in a retrieval system or transmitted in any form or by any means, electronic, mechanical, photocopying, recording or otherwise, without the prior written permission of the publisher.

5. TRIPS: Three or more receivers outside the offensive tackle on the same side of the ball.
6. QUADS: Four receivers outside the tackle on the same side of the ball.
7. PRESS COVERAGE: When a defender lines up in a position where he is close enough that he can touch the receiver as he leaves the line of scrimmage.

C. Receivers are numbered from each sideline. The widest receiver on the **L's** or the **H's** side is #1. The second receiver in is #2 and so on. If the two widest receivers are stacked, the one closest to the Line of Scrimmage is #1 and the receiver behind him is #2.

1. **B's** normal assignment is the #2 receiver on the strong side. **H** and **L** will have the #1 receiver to their side. When there is only one receiver on each side, **B** will key #1 on the **L's** side and **L** will observe backs coming out of the backfield.

2. When there are "twins," **H** and **L** will have the #1 receiver to their side. **B's** primary key is the #2 receiver on the **L's** side. **B's** secondary key is the receiver (#1 or #2) entering middle zone from the **H's** side. **B** must observe primary key, then shift attention to secondary key as soon as possible.

3. When there are "trips" (triple receivers) on one side, **H** and **L** will have the #1 receiver to their side. **B's** is responsible for the #3 receiver. The #2 receiver is assigned based on how close he is to #1 or #3. If he is closer to #1, he belongs to **H** or **L**. If he is closer to #3, he belongs to **B**. When in question, the **L** will key #1 and #2. The Flank official opposite the trips will be responsible for #1 on his side and #2 if there is one. In trips formation, the officials must be prepared to go to zone quickly.

4. When there are quads, the **B** and the flank to that side will work zone. The flank on the other side has the lone receiver to that side.

5. If there is a motion back, strength may change by the motion back's location at the snap. Officials will take a 'snapshot' of the formation *at the snap* and key the appropriate receivers as indicated herein. Again, we are only counting receivers who are outside the tackles at the snap.

6. Flank officials must be aware of all wide players to their sides blocking back toward the ball (possible illegal block below waist, clip, etc.).

7. The most highly skilled TASO officials will know not only which receiver is their key, but which officials are assigned to every receiver. The ability to identify keys instantaneously is developed through practice and experience.

Copyright © 2009 by Texas Association of Sports Officials, Inc *All rights reserved*

No part of this publication may be reproduced, stored in a retrieval system or transmitted in any form or by any means, electronic, mechanical, photocopying, recording or otherwise, without the prior written permission of the publisher.

**ARTICLE 3. EXAMPLES**

**A. ONE RECEIVER TO EACH SIDE (BALANCED FORMATION)**

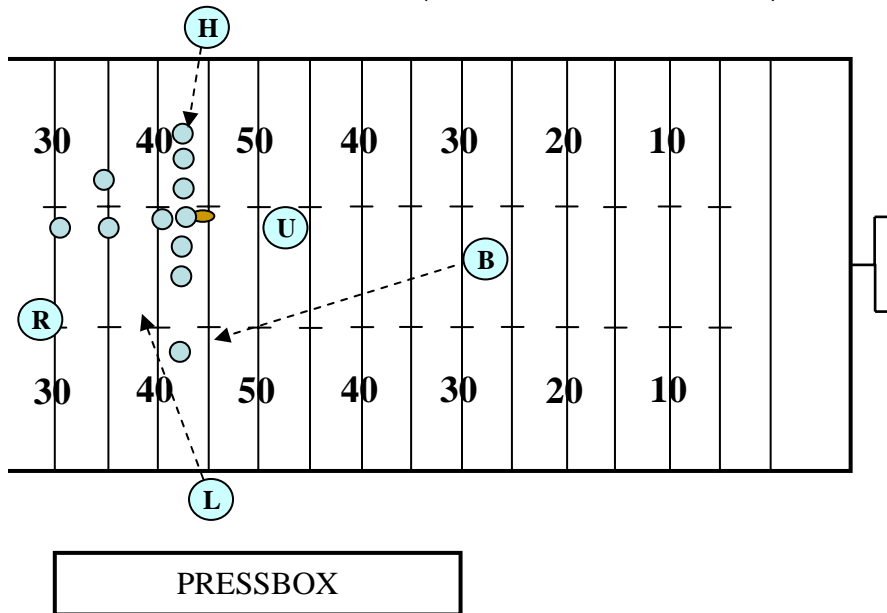

*Balanced formation, strength is declared to L's side. B has the end on L's side. L has no receiver but is responsible for backs leaving the backfield. H is responsible for initial action on or by the end on H's side.*

**B. STRENGTH TO H's SIDE**

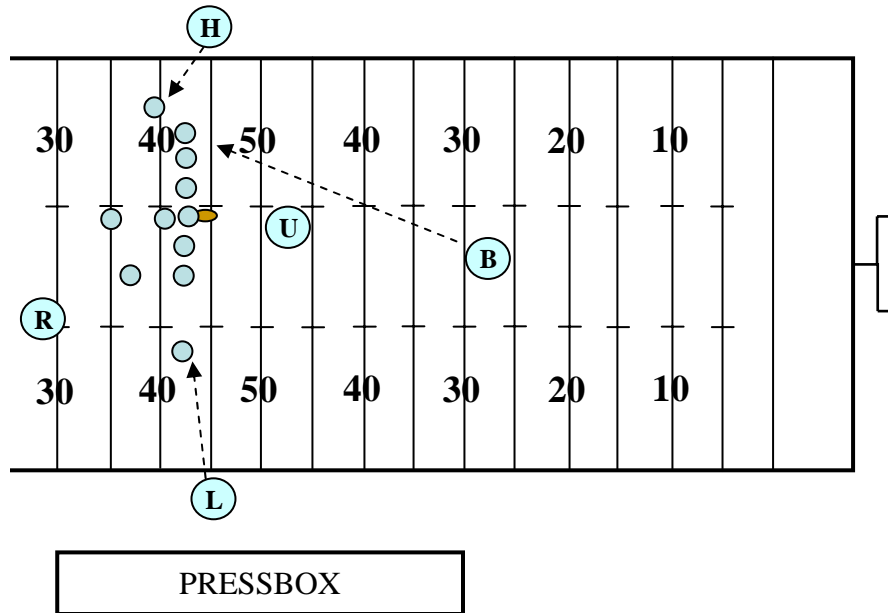

Copyright © 2009 by Texas Association of Sports Officials, Inc All rights reserved

No part of this publication may be reproduced, stored in a retrieval system or transmitted in any form or by any means, electronic, mechanical, photocopying, recording or otherwise, without the prior written permission of the publisher.

When the formation is as above, strength is declared to **H**'s side. **H** has the #1 receiver on **H**'s side. **B** has the #2 receiver on the **H**'s side; **L** is responsible for initial action on or by the end on **L**'s side.

C. STRENGTH TO L's SIDE

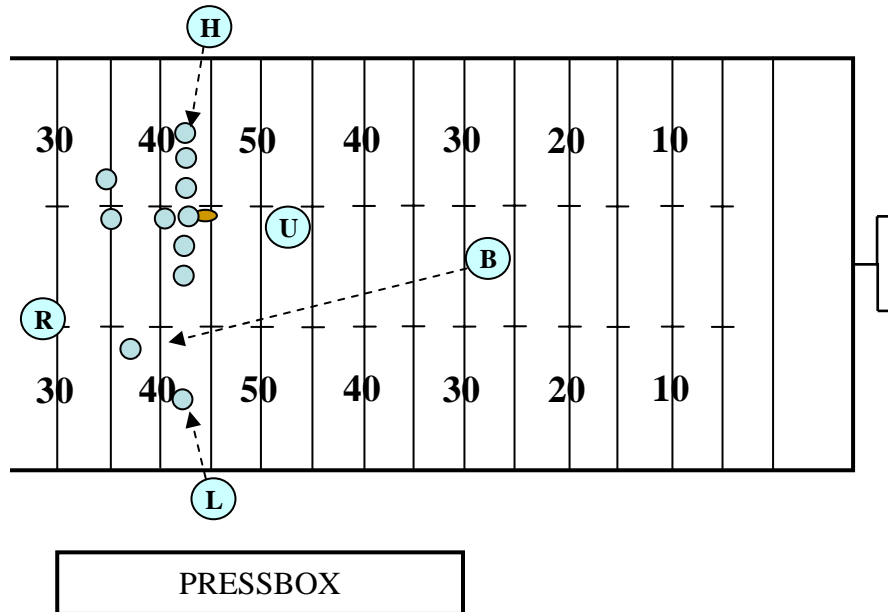

When the formation is as above, strength is declared to **L**'s side. **L** has the #1 receiver to **L**'s side. **B** has the #2 receiver on **L**'s side; **H** is responsible for initial action on or by the receiver on **H**'s side.

D. TWINS (TWO RECEIVERS TO EACH SIDE)

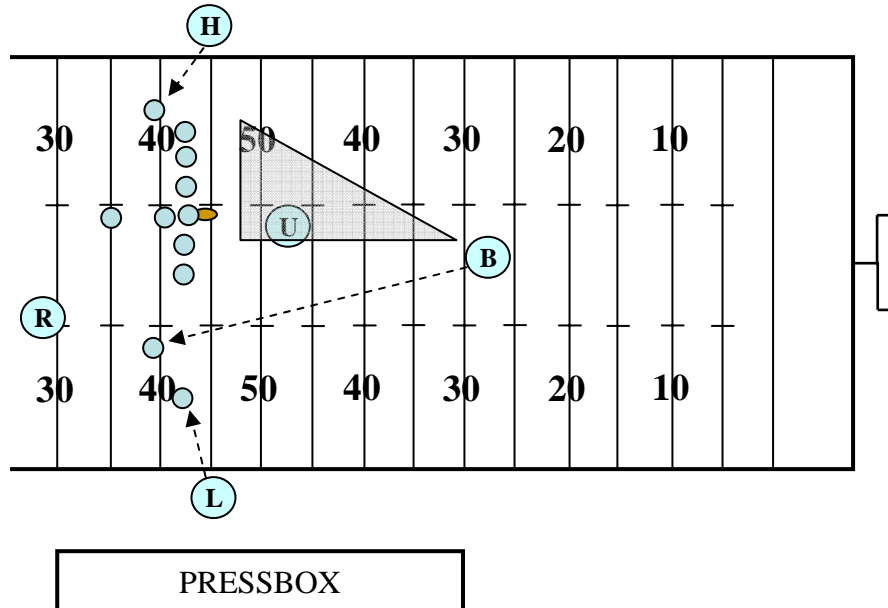

Copyright © 2009 by Texas Association of Sports Officials, Inc All rights reserved

No part of this publication may be reproduced, stored in a retrieval system or transmitted in any form or by any means, electronic, mechanical, photocopying, recording or otherwise, without the prior written permission of the publisher.

When the formation is as above, the formation is "balanced" and the strength is declared to the L's side. H and L will have the #1 receiver to their side. B's primary key is the #2 receiver on the L's side. B's secondary key is the receiver (#1 or #2) entering middle zone from the H's side. B must observe primary key, then shift attention to secondary key as soon as possible.

E. TRIPS (THREE RECEIVERS

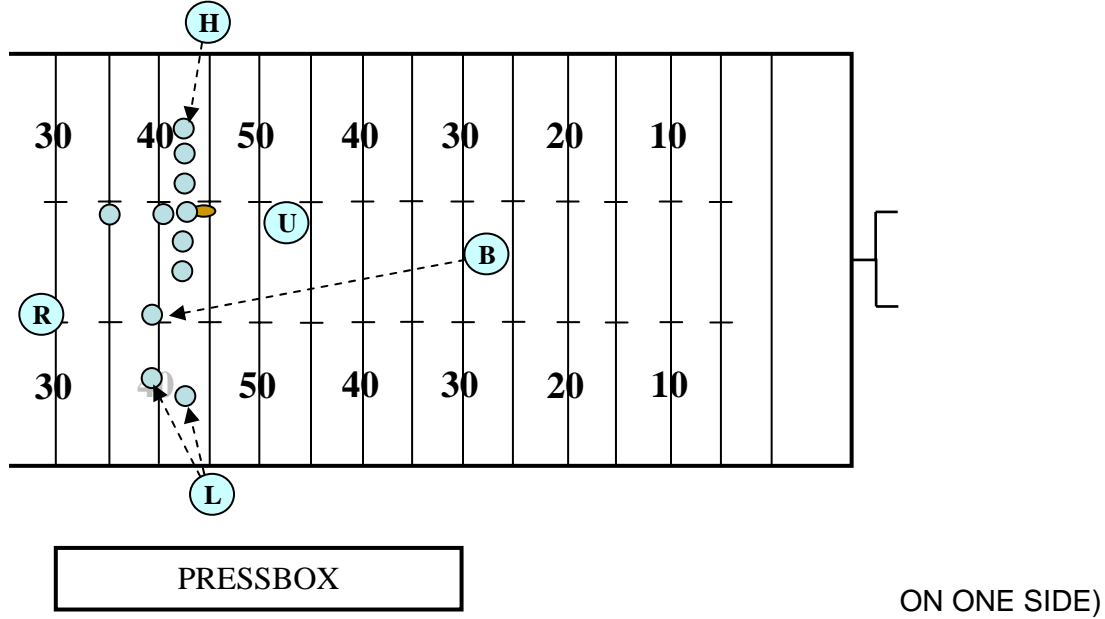

When there are "trips" (triple receivers) on one side, H and L will have the #1 receiver to their side. B's is responsible for the #3 receiver. The #2 receiver is assigned based on how close he is to #1 or #3. If he is closer to #1, he belongs to H or L. In the diagram above, the #2 receiver to the L's side would belong to L. If he is closer to #3, he belongs to B. When in question, the L or the H will key #1 and #2. The Flank official opposite the trips will be responsible for #1 on his side and #2 if there is one. In trips formation, the officials must be prepared to go to zone quickly.

F. QUADS (FOUR RECEIVERS TO ONE SIDE)

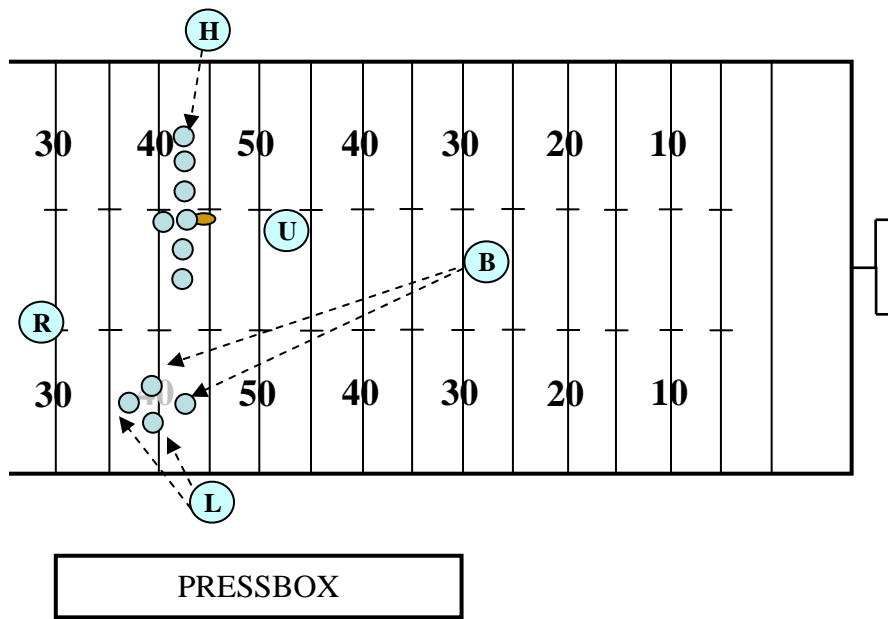

When there are quads, **B** has the two inside and/or front receivers. **B** has the two outside/rear-most receivers. It is important to go to zone very quickly. Both **B** and the flank must know what all four receivers do during the play. Receivers who run deep routes become the responsibility of **B**. Receivers who go across the middle become the responsibility of the flank (**L** in the example). The flank on the other side (**H** in the example) has the lone receiver to that side.

G. MOTION WHICH CHANGES STRENGTH

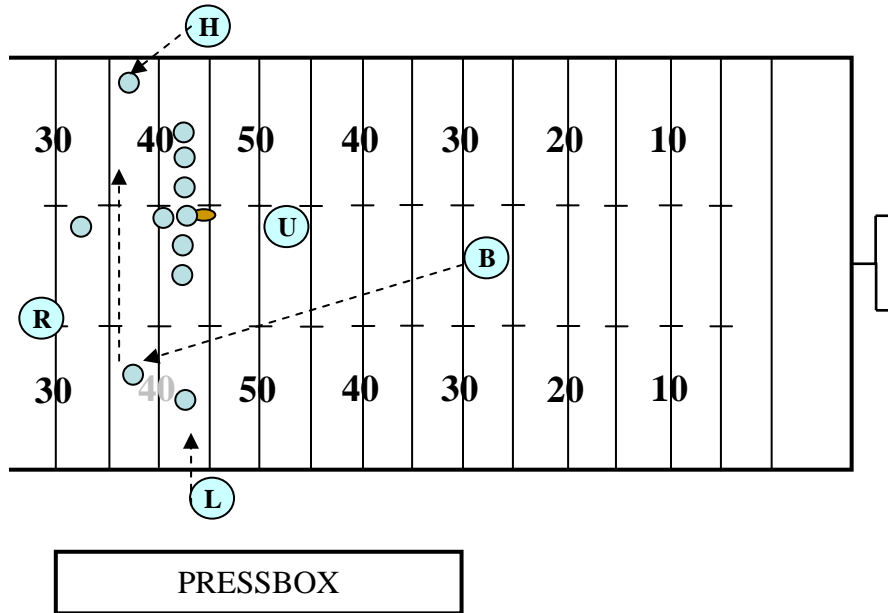

Copyright © 2009 by Texas Association of Sports Officials, Inc All rights reserved

No part of this publication may be reproduced, stored in a retrieval system or transmitted in any form or by any means, electronic, mechanical, photocopying, recording or otherwise, without the prior written permission of the publisher.

*When a back is in motion, as above, strength and keys may or may not change. The officials will determine their keys based on the position of the eligible receivers when the ball is snapped.*

*In the example above, the formation began as "TWINS" (with strength declared to **L's** side.) When the receiver in motion is between the tackles, the strength changes to **H's** side. B's key becomes the #2 receiver on **H's** side. If the receiver in motion continues to **H's** side and is outside the tackle when the ball is snapped, the formation becomes "TRIPS" to **H's** side. **The officials must know their keys well enough to adjust instantaneously.***



**U** A. Position prior to the snap is dictated by the formation however, you must be in a position to see the snap. Under normal circumstances **U** should be opposite the tight end. **U** is responsible for the legality of the snap with assistance from the **R** and wing officials.

B. Just prior to and at the snap **U** will be certain the defensive team does not use words or signals which obviously disconcert their opponents when they are preparing to put the ball in play. **U** should be in position to see the snap and rule on illegal movement of lineman or ball. **U** continues to observe his area of responsibility as long as there is a threat of action.

C. When play develops in his direction, **U** will read the ineligible pass receivers on the line of scrimmage. When a hole opens, he should move away from it as nearly laterally as possible. **U** should check for illegal use of the hands and holding and other fouls by both offensive and defensive players in his area.

D. As the play develops between the tackles, **U**'s primary responsibility to cover the action of players at the point of attack, then behind the ball and finally around the runner.

E. On short, quick runs through the line, between tackles in close formation, **U** generally will sound his whistle when the runner's forward progress stops directly in front of him, on his side of the line of scrimmage. **L and H will indicate forward progress for U to use as assistance.**

F. When the runner moves into the side zone, **U** will clean-up the area between his position and the ball. **U** may, if necessary, move in near the sideline when he is needed to give proper coverage of the action go where the play makes you go. When the ball is in the side zone, **U** is in position to observe action away from the ball and around the runner from an inside out position. When the play is over, all officials have responsibility to rule on late blocks and other illegal acts.

### **ARTICLE 3. HEAD LINESMAN, LINE JUDGE, BACK JUDGE**

**H, L** A. Initial position should be on the sideline. Cover the runner in your side zone beyond the line of scrimmage and out of bounds. Mark forward progress with down field foot, extended slightly toward the spot; don't exaggerate. When marking forward progress, converge rapidly on the dead ball spot when play in your area permits. Be alert to cover forward progress spot when runner has been thrown back.

B. Observe initial charge on your side. You are responsible for blockers and action on ends and linebackers on your side. Pick up runner when he crosses the neutral zone in your area. Spot ball on quick thrusts and close line plays. If play goes away from you, observe action behind runner and assist with action on the pitch man if he does not receive the ball. Maintain a position in relation to the runner's progress observing the play behind the **U** and in front of the **B**. Be alert for the runner returning to your area.

C. After the play is over, assist the **R** or **B** in getting the ball back to the **U**.

**B** D. Cover plays from behind defensive backs. Watch for action by and on your key(s).

Copyright © 2009 by Texas Association of Sports Officials, Inc *All rights reserved*

No part of this publication may be reproduced, stored in a retrieval system or transmitted in any form or by any means, electronic, mechanical, photocopying, recording or otherwise, without the prior written permission of the publisher.

Bracket runner between yourself and either **H** or **L**, depending on the side zone runner is occupying. Maintain enough depth to keep players boxed in. Cover continuing action in advance of the runner.

E. On out of bounds runs, especially in team areas, move into dead ball area and assist flank officials and **R** with maintaining order. The presence of another official stops most dead ball fouls in the team areas. Some out of bounds runs may necessitate coming rapidly into the team area while observing all action. Go where the play makes you go.

**ARTICLE 4. GENERAL**

**ALL A.** Watch for fouls by blockers leading the runner and for fouls after ball is declared dead. The use of signal #7 to indicate dead ball should be used only by **R** when fouls are involved.

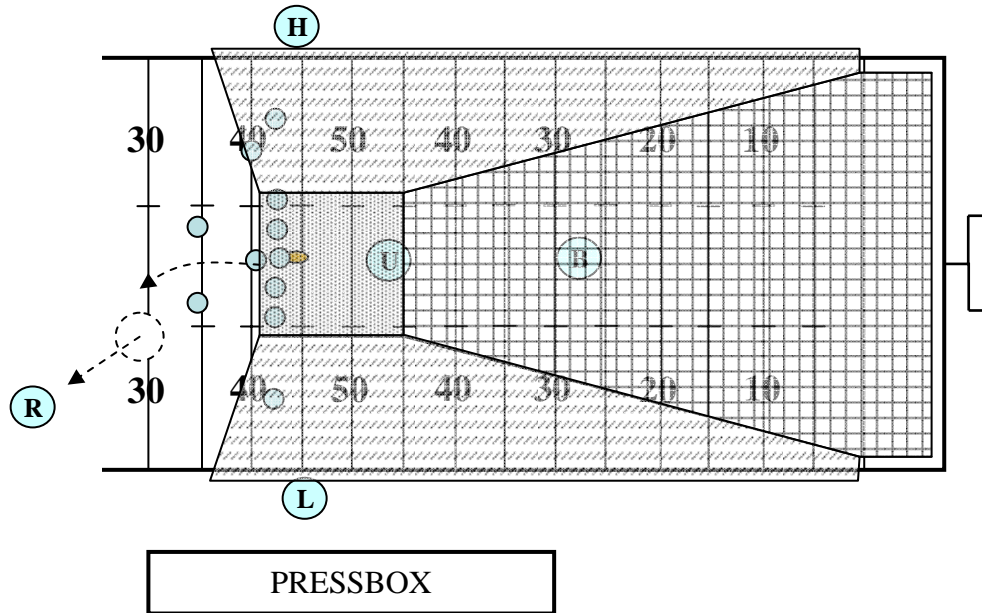
**SECTION 13. FORWARD PASSES****BASIC POSITIONS AND AREA COVERAGE****ARTICLE 1. REFEREE, UMPIRE**

**R A.** When passer retreats, remain wide and deeper than the potential passer. **R** is solely responsible for intentional grounding. He may consult with other officials on the position of eligible receivers. Remain behind line to observe legality of the throw and action against the passer. After the passer throws the ball, continue to observe him until there is no threat of a foul. Ensure that passer is not roughed or thrown roughly to the ground. Verbally alert defenders when passer has released the ball. Continue to observe offensive and defensive action behind the line before moving out of the area. Other officials will cover play downfield. With help from the **H L**, determine whether pass is forward or backward and give appropriate signal. Move to spot of pass; if illegal, drop flag while continuing to officiate. (Note, if the pass is thrown immediately after the snap, the appropriate Wing official will be primarily responsible to determine legality and ensuing action.)

**U B.** Check legality of numbers of interior offensive linemen at the snap. Observe action of players on and directly behind the neutral zone, illegal advance of ineligible and assist with trapped and buttonhook passes. When **U** reads a forward pass play, he should step toward the line of scrimmage. This removes him as a target and opens up his area for shallow drag-pass patterns. This position permits **U** to observe linemen moving illegally downfield. After observing play of linemen and their contact with up blocking backs, pivot to assist on low trajectory and short passes over the center of the line. Know where ball first touches

Copyright © 2009 by Texas Association of Sports Officials, Inc *All rights reserved*

No part of this publication may be reproduced, stored in a retrieval system or transmitted in any form or by any means, electronic, mechanical, photocopying, recording or otherwise, without the prior written permission of the publisher.

anything on forward pass. Use signal #11 when appropriate. Assist **R** in determining legality of forward passer.

Copyright © 2009 by Texas Association of Sports Officials, Inc *All rights reserved*

No part of this publication may be reproduced, stored in a retrieval system or transmitted in any form or by any means, electronic, mechanical, photocopying, recording or otherwise, without the prior written permission of the publisher.

**ARTICLE 2. HEAD LINESMAN, LINE JUDGE, BACK JUDGE**

**H, L A.** Assist **U** in checking the legality of numbers of offensive interior linemen. Check legality of positions for players with eligible numbers. After initial charge of linemen, move into position to check blocking and contact of eligible receivers and linebackers. Be ready to rule on the direction of a quick quarterback pass. (Note, if the pass is thrown immediately after the snap, the appropriate Wing official will be primarily responsible to determine legality and ensuing action. Drift downfield cautiously for the first 5-7 yards, approximately halfway between flat zone and deepest receiver. While pass is in flight, move to the most advantageous position to judge the play. Always be prepared to come back to rule on play near the neutral zone in addition to sideline action. Observing the wide initial position is helpful in covering any pass. If potential passer decided to run, you must cover him beyond the neutral zone. Entire sideline is your responsibility.

**B.** After an incomplection, obtain ball from Ball Person and form a relay to return the ball to official nearest the previous spot.

**C.** If an airborne player receives a pass near the sideline and first returns to the ground out of bounds, after giving the incomplete signal, the covering official may, with both arms, give a sweeping motion toward out of bounds.

**B D.** Cover plays from behind deepest receivers. Initial focus in on you key(s) as the leave the Line of Scrimmage. Once receivers are no longer threatened at the Line of Scrimmage, the B should transition quickly into zone coverage. Bracket pass receivers between yourself and either **H** or **L**, depending on location

**ARTICLE 3. ALL**

**A.** Be alert for an illegal pass, especially after a completion, observe touching or catching by an ineligible player. Watch particularly for holding or illegal contacting eligible receivers and all contact beyond the neutral zone both before and after the pass is thrown. Observe action when opposing players contest for the pass. When ruling on pass reception involving the sideline, only the signal governing should be used. Repeat signal three times. After an incomplection, obtain a ball from a Ball Person and form a relay to return ball to official nearest the previous spot.

**B.** When contact occurs on a pass that is uncatchable, and the covering official does not drop his penalty marker, the covering official will give the uncatchable pass signal. (S17)

## SECTION 14. GOAL LINE PLAYS

### Basic Position and Coverage

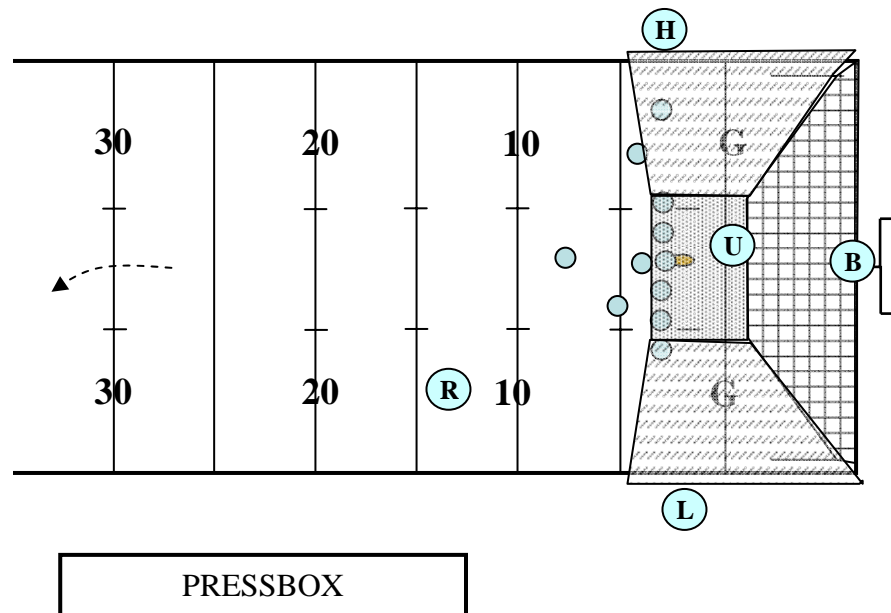

*Except when a field goal attempt is indicated on a try, the crew will setup as on any other short yardage down. (See Section 17 for Field Goal Attempts)*

#### ARTICLE 1. GOAL LINE

**R** A. Position and coverage the same as for other scrimmages with the forward point of advancement usually determined by the wing official. Signal score only after being positive all requirements are met.

**U** B. Adjust your position to account for proximity to the goal line. When runner has made quick thrust into the line at your feet, be sure the ball is not moved forward after it is declared dead. Never signal score but assist the **H**, **L**, verbally or visually if necessary.

**H, L** C. Initial position must be wide on or near the sideline. Move toward the goal line and rule on the score or on accurate forward point when you see the ball. Be alert for a forward pass.

**B** D. Ordinarily need not be as deep as for other scrimmage plays. Start on the end line if snap is from on or inside the 10 yard line. Assume complete responsibility of end line coverage. In short yardage situations, i.e. running plays, be alert for illegal activities in the fringe areas.

**U, H, L** E. If ball's forward progress stops short of the goal line, move in on the ball, mark and hold the dead-ball spot until ball is spotted for the next play.

Copyright © 2009 by Texas Association of Sports Officials, Inc *All rights reserved*

No part of this publication may be reproduced, stored in a retrieval system or transmitted in any form or by any means, electronic, mechanical, photocopying, recording or otherwise, without the prior written permission of the publisher.

**ALL F.** Indicate score by touchdown signal only when in position to determine same, being positive that requirements are met.

Copyright © 2009 by Texas Association of Sports Officials, Inc *All rights reserved*

No part of this publication may be reproduced, stored in a retrieval system or transmitted in any form or by any means, electronic, mechanical, photocopying, recording or otherwise, without the prior written permission of the publisher.

**SECTION 15. FUMBLES**

**ARTICLE 1. SIGNALS**

A. The nearest official should point in the proper direction, no matter who recovers. **R** will then signal the next down when he makes the ball ready for play.

**ARTICLE 2. DIGGING OUT FUMBLES**

A. Should it become necessary to "dig out" a fumble, the official nearest the ball should dig for the ball. The next official to the area should signal to stop the clock and look to the clock to ensure it is stopped. The stop the clock signal should be relayed by the remainder of the crew.

B. When the digging official determines possession he should verbally relay possession information to the nearest standing official, normally the **R**, who will then signal the proper direction. If possible, the signaling official will point to the recovering player to assist the press box. Only the **R**, if he is not the signaling official, should relay the direction signal. See Section 8 for bean bag mechanics on fumbles.

**SECTION 16. SCRIMMAGE KICKS (PUNT PLAYS)**

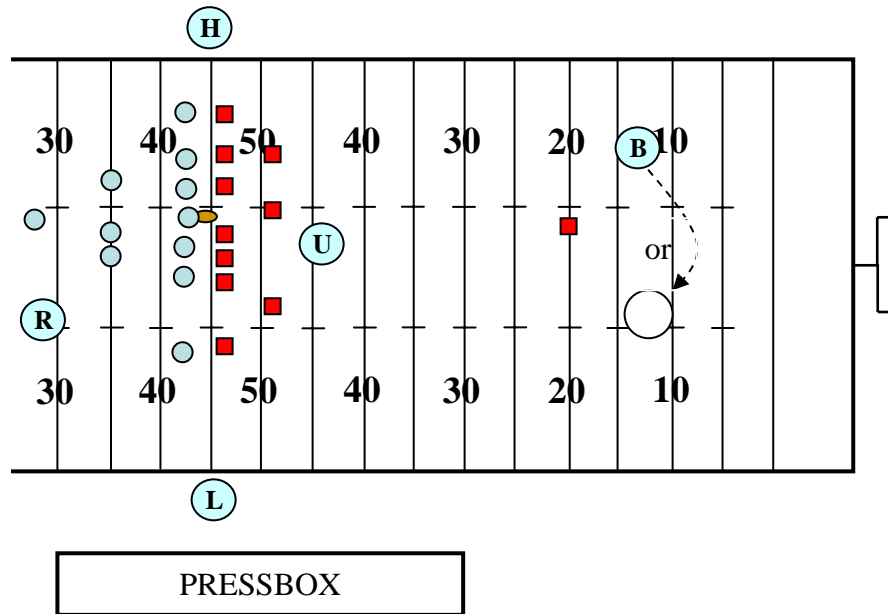

**R** watches play on kicker, **H** holds until ball crosses neutral zone, then moves slowly downfield covering on his side between line of scrimmage and deep receiver(s). **U** takes initial position 8 - 10 yards deep. **L** stays on line until it is apparent it is a kick, and then moves downfield covering his side between the line of scrimmage and the deep receiver(s). **H** and **L** be alert for blocked or partially blocked kick. **B** takes a position behind receiver(s). **H**, know if kick crosses neutral zone. Be alert for delay by kicking team designed to confuse opponents.

**ARTICLE 1. BASIC POSITIONS AND COVERAGE**

Copyright © 2009 by Texas Association of Sports Officials, Inc All rights reserved

No part of this publication may be reproduced, stored in a retrieval system or transmitted in any form or by any means, electronic, mechanical, photocopying, recording or otherwise, without the prior written permission of the publisher.

**R A.** Takes position at the side of the kicker, wide enough to see the ball from snap to kick. Be able to see blockers and kickers at the same time. Be in position to be even with, or slightly in front of the kicker when ball is kicked. Adjust to the situation; warn potential kicker if he is on or outside the end line prior to the snap.

**R, U B.** Count offensive players. If Team A “rushes” substitutes on the field, insure the defense has an opportunity to adjust. **U** should stand over ball until motioned off by the **R**.

**C.** Be alert for delay by kicking team to confuse opponents.

**U D.** Adjust to field position 8 to 10 yards deep favoring the **L**'s side of the field. Face the offensive line during the initial charge, observing the action of Team A and Team B players.

**H, U E.** Same as for runs and passes. Check offensive linemen for on or behind the line and for an unbalanced line.

**B F.** Take position outside and behind the deep receivers. Position yourself on either side so that you may have the best view on the catch. Adjust to play area and assume responsibility for coverage into either sideline. If necessary to retreat, move backward at a 45° angle.

## **ARTICLE 2. AFTER THE SNAP**

**R A.** Watch blocking and illegal action by players behind the line. Observe action of and against the kicker, using signal #11 if appropriate, and observe players while proceeding slowly downfield if the kick remains inbounds. If the flight of the kick is toward a sideline, move quickly to position in line with the flight and use arm signals to direct the official covering that sideline to out of bounds spot. When correctly aligned, drop your arm as indication that the official hold the spot until ball is spotted for next down.

**B.** If the kick is caught or recovered downfield, be conscious of coverage of either sideline. Be prepared to take over the runner.

**R, U, H, L C.** Be alert for blocked kick. Be alert for recovery and advance.

**U D.** Look down the line at the initial charge, checking blocks of offense and action by defensive players. Observe defensive linemen over center to avoid serious injury to snapper. Shift observations to contact between defensive players. After players go past your position turn and move toward the return area, observe the center picture for illegal action by players of either team, assist with substitutes.

**H, L E.** If the kick is short or partially blocked, know if it crossed the neutral zone.

**H F.** Primary responsibility to know if kicked ball crosses neutral zone.

**H G.** After initial line charge, observe offensive backs for holding, and defensive holding in the line area. When the kick has clearly crossed and will not threaten the neutral zone, release and move downfield. If the kick is short to your side, observe first touching, legal or illegal, kick catch interference, valid or invalid signal for fair catch. Maintain position to cover in front of the runner after catch or recovery of the kick, maintain coverage until the runner

Copyright © 2009 by Texas Association of Sports Officials, Inc *All rights reserved*

No part of this publication may be reproduced, stored in a retrieval system or transmitted in any form or by any means, electronic, mechanical, photocopying, recording or otherwise, without the prior written permission of the publisher.

cuts toward the opposite side or, if on your side, is picked up by you. You have responsibility for the entire sideline on your side.

**L H.** After initial line charge, observe offensive backs for holding, and defensive holding in the line area. Stay on line until it is apparent it is a kick, immediately move downfield in an easy run. If the kick is short to your side, observe first touching, legal or illegal, kick catch interference, valid or invalid signal for fair catch. Maintain position to cover in front of the runner after catch or recovery of the kick, maintain coverage until the runner cuts toward the opposite side or, if on your side, is picked up by you. You have responsibility for the entire sideline on your side.

**H L I.** During the kick, observe action on and by the “flyers” (Team A players charging the receiver) and receivers positioned close to the line of scrimmage. When the ball is not in your area, take a position to observe action in your area ahead of the runner.

### **ARTICLE 3. AFTER THE KICK**

**B A.** If kick is short to either sideline, the sideline official will assume responsibility for the ball. Observe action in front of the ball. On all other kicks cover the receiver, taking a position ahead of the receiver if possible. Observe first touching, interference, and fair catch situations. Cover kicks on ground or in air which go 25 yards or more. If in doubt as to spot of out of bounds kick in the air, raise hand and **R** will assist. If there is any question regarding covering official, communicate verbally.

**H, L B.** If kick goes to side opposite you, drift downfield while kick is in flight, observing all action and be alert for a sudden cut toward your side and possible exchange in coverage of the runner. When you do not have the ball, take a position to observe action in your area ahead of the runner.

**C.** Mark and hold out of bounds spot of rolling kick on your side. Be alert to cover and accept **R**'s signal in spotting out of bounds kick in flight.

**B D. B** will be primarily responsible for ruling on fair catch signal in his area. **L** and **H** observe other action surrounding the ball. If player signaling fair catch does not touch the ball, **L** and **H** must observe legality of his actions until the ball becomes dead. Be ready to rule on kick in end zone. Be alert for batting. Use a bean bag to mark the spot where kick ends.

### **SECTION 17. TRY AND FIELD GOAL PLAYS**

Copyright © 2009 by Texas Association of Sports Officials, Inc *All rights reserved*

No part of this publication may be reproduced, stored in a retrieval system or transmitted in any form or by any means, electronic, mechanical, photocopying, recording or otherwise, without the prior written permission of the publisher.

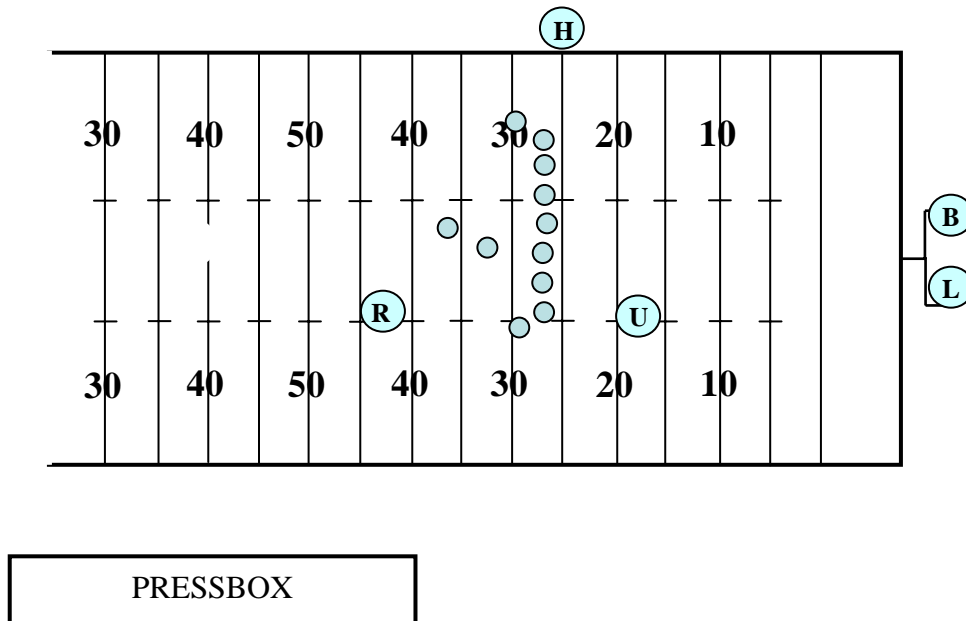

*On field goal attempts **B & L** will take positions slightly behind the goal posts. When the kick is made, adjust positions to rule on kick. When the ball strikes the cross bar, **B** is solely responsible for the result of the attempt and will give the appropriate signal. **B** and **L** should use either signal #5 or signal #10 as appropriate.*

**ARTICLE 1. BASIC POSITIONS AND COVERAGE**

**R** A. On a try or field goal, **R**'s position is a yard or so to the rear and several yards to the side of the potential kicker, (favoring the **L** sideline), facing the kicker where **R** can see the ball when spotted for the kick. Covers as usual if a run or pass. Assist in sideline coverage if run develops to **L**'s vacated side. Signal score after being positive that requirements are met. Rule on roughing or running into the kicker and/or holder.

**U** B. Adjust position to favor vacated **L** side. Adjust depth based on length of kick. Look down the line at the initial charge, checking blocks of offense and action by defensive players. Observe defensive linemen over center to avoid serious injury to snapper. Shift observations to contact between offensive and defensive players. Assist in goal line coverage if run develops to **L**'s vacated side.

**H** C. Responsible for legality of snap and entire line of scrimmage. Quickly move to goal line if run develops.

**H** D. If the kick is short or partially blocked, know if it crossed the neutral zone.

**L** E. Responsible for your upright goal post. If run develops to your vacated side, quickly move along back line to back pylon to rule on the sideline. Next move is toward goal line to

Copyright © 2009 by Texas Association of Sports Officials, Inc *All rights reserved*

No part of this publication may be reproduced, stored in a retrieval system or transmitted in any form or by any means, electronic, mechanical, photocopying, recording or otherwise, without the prior written permission of the publisher.

assist. If run situations develop to **L**'s side, **L** has primary sideline responsibility with **R**'s assistance. If attempt is short and ball remains alive, officiate as a scrimmage kick.

**B F.** Responsible for your upright goal post and rule if ball hits cross bar on kick. If run develops, move to goal line to assist in ruling. If attempt is short and ball remains alive, officiate as a scrimmage kick. Sound whistle when ball becomes dead on attempted field goals and kick tries.

**L, B G.** When the field goal or try attempt narrowly passes outside an upright, the official nearer the ball may give a sweeping motion with both arms away from the upright.

**ALL H.** All officials should be alert for runbacks. Assist each other in getting ball spotted for next down.

**I.** Officiate all try downs as a normal scrimmage down and do not sound whistle until ball is dead.

## **SECTION 18. TIME OUTS**

### **ARTICLE 1. PROCEDURES**

**R A.** Indicate a full length charged time out by facing the requesting team. Give time out signal, then with both arms extended shoulder high, giving three chucks in its direction. Indicate a third charged time out by following this signal with three tugs on an imaginary steam whistle.

**B.** Check with **U** the number of time outs charged to each team and the playing time remaining in the period.

**C.** Notify the head coach when his team time outs are exhausted.

**H, L D.** Notify a coach from team on your sideline of the number of time outs remaining to each team and of the remaining time in the period.

**ALL E.** When relaying time outs to fellow crew members, relay the number the team has taken. When relaying the time outs to players and coaches relay the number they have remaining.

**R F.** Quickly take position, well clear of officials and players, and be ready to handle any emergency.

**G.** Upon **B**'s signal that the time-out interval has expired, or when both teams indicate readiness to resume before that time, direct teams to prepare to resume play. Go to position, get ready signals from each captain, and declare the ball ready for play within five seconds.

**ALL H.** Record time left on clock and number of requesting player when charged team timeout is requested. Do not huddle unless necessary.

Copyright © 2009 by Texas Association of Sports Officials, Inc *All rights reserved*

No part of this publication may be reproduced, stored in a retrieval system or transmitted in any form or by any means, electronic, mechanical, photocopying, recording or otherwise, without the prior written permission of the publisher.

**H, L I.** Take a position halfway between your team and its team area. Direct teams to prepare to resume play upon signal from **B**.

**J.** Check number of players in your teams huddle. Repeat this check after taking position for the next down. **H & L** are responsible for teams on their side.

**U K.** Quickly take position over the ball. Remain over the ball until released by **R**.

**B L.** Time the one-minute time-out interval. When 20 seconds remain in the interval, sound your whistle three times, short but sharp. Move to your position and give a visual signal to the **R** when the interval expires. Be alert to assist **R** if needed.

## **ARTICLE 2. REFEREES TIME OUT**

**R A.** Signal time out, then indicate **R**'s time out by tapping chest with hands. Stay at the ball.

**B.** Only **R** may stop the clock for a coach's conference. If the coach is not correct on his reason for requesting a coach's conference, he will be charged with a time out. After the time out has been charged to the coach, the procedure for a team time out will be carried out. This includes a full time allotment.

**C.** Signal time out when Team A is awarded a first down.

**D.** Declare ball ready for play as soon as need for time out has been met.

**ALL E.** Signal time out and carry out usual duties.

**F.** When either team is in possession of the ball in advance of the line to gain, covering official indicates time out.

**G.** If game is disrupted for any reason, record down, team in possession, position of the ball and time remaining in the game.

## **ARTICLE 3. INJURY TIME OUTS**

**ALL A.** Same as team time out, however permit as much time as is necessary. SAFETY OF INJURED PLAYERS IS MOST IMPORTANT. Use signal #3, followed with tapping hands on chest.

**B.** Do not allow players to assist teammates but direct that they wait for trained staff.

**C.** **R** may permit water attendants to tend to their teams on the field during extended injury timeouts.

## **SECTION 19. MEASUREMENTS**

### **ARTICLE 1. PROCEDURES**

**ALL A.** When establishing forward progress or the end of the run, be sure there is no need for measurement before announcing the down. If close, announce the down and be alert for either captain's request for measurement, if doubtful, call for measurement without captain's

Copyright © 2009 by Texas Association of Sports Officials, Inc *All rights reserved*

No part of this publication may be reproduced, stored in a retrieval system or transmitted in any form or by any means, electronic, mechanical, photocopying, recording or otherwise, without the prior written permission of the publisher.

request. In usual circumstances, the **L** will assist **R** with determining obvious first downs by stopping the clock. When a play ends close to the down marker, the **L** can assist the **R** by indicating "close". The **R** can then move to the spot to determine if a measurement is needed or if a first down will be awarded.

**B B.** Will ensure the ball is not moved after being spotted for measurement. Hold ball if necessary.

**C.** Clear the area of officials and players for press box view.

**R D.** When the ball becomes dead in a side zone or out of bounds and measurement should be at the dead ball spot, have covering official place the ball at the proper spot. Indicate to the **H** and to the press box that a measurement is needed.

**H E.** Instruct the box operator to place the box at the position of the front stake. Grasp chain at point of its intersection with the back edge of the marked yard line nearest the rear rod, after clip of snap is affixed to mark the correct point, grasp the chain firmly as assistants carry it to the position on the field.

**F.** Maintaining grasp, place the correct point of the chain on the back edge of the proper yard line, call "ready" and be sure the chain is not jerked from your grasp when tightened by the **U**.

**L G.** Go to yard line nearest rear stake. Mark a spot perpendicular to the ball to aid. Assist the **H** in positioning the chain for an accurate measurement.

**U H.** Take forward rod. Wait until **H** calls "ready" then carefully tighten the chain only once. Don't pull or jerk it. Have the rod perpendicular to the ground at the side of the ball until **R** announces his ruling, and then return rod to the chain crew.

**R, H, U G.** Check for kinks in chain and be sure that chain is taut.

**R H.** See that the **U** is ready. Observe the relative position of ball and point to be gained, and then announce your ruling.

**All.** I If short of a first down, use the forward point established on the chain when spotting the ball at the inbounds line. If alternate game ball is available following the measurement, leave the ball in the side zone until an alternate ball is placed at a corresponding inbounds spot.

**H J.** If not first down, retain firm grasp and personally set the chain at its original spot on the sideline. Check the point marked by your assistant.

**R U K.** Remain over the ball and announce down and distance. Get ready signals from captains while **H** is resetting chain. When **H** is ready, declare the ball ready for play.

## **SECTION 20. CALLING FOULS/PENALTY ENFORCEMENT**

Copyright © 2009 by Texas Association of Sports Officials, Inc *All rights reserved*

No part of this publication may be reproduced, stored in a retrieval system or transmitted in any form or by any means, electronic, mechanical, photocopying, recording or otherwise, without the prior written permission of the publisher.



### ARTICLE 1. PROCEDURES

**ALL A.** The calling official will drop or throw marker at proper spot, mentally marking the yard line. If ball is alive, withhold whistle until the ball becomes dead; then continue to sound whistle until you are certain other officials are aware a foul has been called. The official should then verbally communicate the information to the **R**. There should be no visible signal.

**B.** Know status of ball if it is in play. Make mental note as to whether the clock should be started on the ready or on the snap.

**C.** Do not place a hand on or point to the offending player. Official who calls disqualifying foul notifies the head coach. Nearest official will notify, by position or number, a coach of non-disqualifying fouls by his team. On encroachment, offside, false start fouls, etc., if more than one marker is down, calling officials should consult with **R** or **U** whichever is appropriate, before reporting foul. If **U** is involved, he should report the foul to the **R**.

**D.** After calling foul, get **R**'s attention as soon as ball is dead, sound whistle and give verbal description. It is your duty to make sure another official is covering the spot of foul if foul is spot foul; then go to **R** and report the foul fully as follows:

1. Foul called. Who fouled? Offense or Defense, Return or Kicking team. What the foul was? Where did the foul occur? Behind or beyond LOS. When did the foul occur? Live or dead ball.
2. Offending team, including jersey color and A/B, offense/defense or kicking team/receiving team.
3. Offending player's number or position.
4. Spot of foul, previous spot, end of run or end of kick.
5. Status of ball when foul occurred.

**H, L, B E.** Foul called by another official:

1. If ball is not at dead ball spot, assist in getting it there.
2. Cover and hold dead ball spot and mark end of run. Leave ball on ground.

Copyright © 2009 by Texas Association of Sports Officials, Inc *All rights reserved*

No part of this publication may be reproduced, stored in a retrieval system or transmitted in any form or by any means, electronic, mechanical, photocopying, recording or otherwise, without the prior written permission of the publisher.

3. If the foul is a spot foul, cover and hold spot of foul.
4. Observe players and assist where needed.

**H, L, B F. Covering Spot of Foul:**

1. Hold spot as long as necessary. Ascertain foul and offending team. When **U** starts to enforce the foul, pick up marker of official who called foul.
2. If enforcement spot is different from spot of foul, see that it is covered by an official.
3. If enforcement is from spot of foul, **L** shall hold spot during enforcement. **U** will release him/her.
4. When fouls are committed that require enforcement at the spot of the next free kick, **R** will give the preliminary signal and point to the next free kick spot. **U** will repeat the signal following enforcement from the succeeding spot.

**R G.** When foul or fouls are reported to the **R**, he/she will immediately give preliminary signal or signals to press box side before explaining options to captains. Notify both captains if loss of down is part of the penalty. Give dead ball signal before giving the signal for a dead ball foul.

**H.** If a choice is obvious, announce it and proceed with enforcement or declination. If captain objects, explain alternatives and conform to his choice. If choice is not obvious, explain foul or fouls and the options, state options briefly, but correctly, clearly and courteously. Notify captain of offending team of foul called and number and position of offending player (if possible).

**L I.** Hold enforcement spot until penalty is completed. (Exception: Penalties assessed on kickoff).

**R J.** When penalty is to be enforced, instruct **U** as to point of enforcement and yardage to be marked off.

**U K.** Take a position near **R** when he explains options to a captain. If penalty is to be enforced, follow **R**'s instructions in marking off the penalty. **U** will carry ball and place in position when penalty is enforced. If "tick" marks are available, use them to assist in getting the correct yardage. Otherwise, mark of the yardage as instructed.

**H L.** When **U** starts to mark off penalty, be on or near the sideline and move to the succeeding spot. Check visually with **U**; if enforcement is correct, direct assistants to move down indicator and direct moving of chains if appropriate.

**R M.** While **U** is marking off penalty, take position in clear where you can be seen. Give signal to press box side of the field only. If equipped with a microphone, do not announce the number of the player committing the foul.

1. If penalty is accepted, signal foul and extend one arm in pointing fashion, horizontally in direction of offending team.
2. If penalty is declined, signal foul, extend one arm in pointing fashion, horizontally in direction of offending team and then give the penalty declined signal. (#10)
3. If penalties offset, signal one foul, extend one arm, in pointing fashion, horizontally in direction of offending team, repeat this procedure for foul by other team, then give penalty declined signal.

Copyright © 2009 by Texas Association of Sports Officials, Inc *All rights reserved*

No part of this publication may be reproduced, stored in a retrieval system or transmitted in any form or by any means, electronic, mechanical, photocopying, recording or otherwise, without the prior written permission of the publisher.

4. While facing press box, indicate the number of the next down.
5. When fouls are committed that require enforcement at the next free kick, the **R** will give the preliminary signal and point to the next free kick.

**U N.** Cover the ball after completing penalty and **R** is in process of giving signal for fouls.

**R O.** Declare ball ready for play. Start clock if appropriate.

**ALL P.** Official calling foul is primarily responsible to see that **R** and **U** assess penalty properly in all respects.

## **SECTION 21. CLOSE OF A PERIOD**

### **ARTICLE 1. PROCEDURES**

**ALL A.** Near the end of a period, all officials should be aware of the time remaining before the start of each play.

**R, U B.** When time expires, sound whistle only if ball is dead. The termination of a period is then indicated by the **R** holding a ball over his head with one hand. The **R** is primarily responsible for determining the end of any period.

**C.** At close of first and third periods, see that ball is not disturbed until exact position for transfer has been determined. Turn the ball over to the **B** at close of second period.

**U D.** Keep **R** informed of remaining playing time. Indicate by inconspicuous signal whether there is ample or scant time for next snap. Advise **R** at the end of the down if time expired while the ball was in play.

## **SECTION 22. ONE-MINUTE INTERMISSIONS**

### **ARTICLE 1. PROCEDURES**

**ALL A.** Observe players as they move to the other end of the field.

**B, L B.** Move downfield assuming responsibility of respective teams.

**B C.** Time the one-minute intermission between periods and the one-minute intermission after a safety, try or successful field goal. When 20 seconds remain in the intermission, sound your whistle three times, short but sharp. Move to your position and give a visual signal to the **R** when the intermission expires.

**R D.** Record and announce yard line on which forward point of ball rests and the down and distance loudly and clearly enough for other officials to hear.

**E.** Carefully measure distance from nearest marked yard line to forward point of the ball. Distance from the inbounds line may be estimated.

**F.** Check with the **H** and **U** on location, down and distance and proceed to corresponding yard line beyond the 50-yard line and spot the ball. Do not resume play until one minute has elapsed.

Copyright © 2009 by Texas Association of Sports Officials, Inc *All rights reserved*

No part of this publication may be reproduced, stored in a retrieval system or transmitted in any form or by any means, electronic, mechanical, photocopying, recording or otherwise, without the prior written permission of the publisher.

**U, L, B G.** Record yard line, down and distance and check **R**, both before and after he changes position of the ball.

**H H.** Determine the yard line which intersects the chain between the rods. Record the down, distance and yard line upon which the ball rests. Grasp the chain at the back edge of the marked yard line, reverse the chain and the assistants holding the rods and move to corresponding line in the other half of the field. Hold the point on the chain at the intersection of that line with the sideline while the assistants tighten the chain.

**U, H, L, B I.** After **R** spots the ball, check for correct spotting and check the down and distance to gain with **R**.

**ALL J.** During the intermission between periods, after other prescribed duties are completed, take positions to observe the teams, but away from the team areas. Upon the **B**'s 20-second remaining notification, verbally notify both teams that 20-seconds remain, and move to positions for the succeeding play.

**U K.** When the succeeding play will be a free kick, upon the **B**'s 20-seconds remaining signal, deliver the ball to the kicker between the inbounds lines, and quickly return to the sideline. Be on the sideline and ready when the intermission expires.

**R L.** Upon the **B**'s visual signal that the intermission has expired, ensure both teams are ready to play, then immediately declare the ball ready for play.

## **SECTION 23. INTERMISSION BETWEEN HALVES**

### **ARTICLE 1. END OF A PERIOD**

**R A.** From the end zone give the start the clock signal when field is clear of officials and players.

**B B.** Keep other officials informed as to running time. Make sure crew arrives at field to start second half on time, at least 3 minutes before kickoff.

### **ARTICLE 2. PRIOR TO KICKOFF**

**R, U A.** Check with other officials regarding second half choices.

**L, H B.** Check with Head Coach on your sideline and secure the second half option.

**R, B C.** Five minutes prior to the end of the half-time intermission go to the team that occupies the team area opposite the press box.

**U, L D.** Five minutes prior to the end of the half-time intermission go to the team that occupies the team area on the press box side.

**L, B E.** Bring your team to the team area three minutes before kickoff.

**H F.** Make certain your assistants are ready and send them to the receiving team's 20- yard line. Remind them to stay behind the restraining line during the kickoff.

Copyright © 2009 by Texas Association of Sports Officials, Inc *All rights reserved*

No part of this publication may be reproduced, stored in a retrieval system or transmitted in any form or by any means, electronic, mechanical, photocopying, recording or otherwise, without the prior written permission of the publisher.

**ALL G** . Meet **R** at the center of the field and then move briskly to kickoff positions following the same procedure as the start of the first half.

*NOTE: **U** assures that he has correct ball for the kickoff.*

## **SECTION 24. EXTRA PERIODS**

### **ARTICLE 1. END OF REGULATION PLAY**

**ALL A.** Direct, and escort if necessary, the teams to their respective team areas.

**R B.** Announce or otherwise notify press box that: "Regulation play has ended with a tie score. There will be a brief intermission followed by an extra period of play."

**ALL C.** Gather at the center of the field and review extra period rules and procedures.

**ALL D.** Approximately three minutes following the end of regulation play, break to positions for coin toss.

**B E.** Ensure field clock is turned off or displays 00:00. Ensure play clock is operational.

**R, U F.** Remind head coach of team on your sideline of extra period rules, particularly coin toss and option procedures, and time-outs.

### **ARTICLE 2. COIN TOSS**

**All A.** Approximately four minutes following the end of regulation play, conduct coin toss. Assume same duties as for coin toss prior to start of game (see Section 5), except no introductions. It is acceptable for the Head Coach or designee to serve as the captain for the coin toss for extra periods.

**R B.** Remind captains/coaches that the winner of the toss may not defer choice. Conduct toss, obtain choices, and move captains with their backs to their respective goal lines. Place hand on shoulder of captain (nearest press box) of team winning toss. Stand adjacent to team (to press box side) that will be on offense first and give signal S8 (first down). Simultaneously, announce choices if equipped with field microphone.

**ALL C.** Immediately move to scrimmage positions and begin play without delay.

### **ARTICLE 3. ADDITIONAL EXTRA PERIOD**

**ALL A.** When an additional extra period is required, immediately conduct the option selections with the captains. **R** and **U** move directly to the center of the field and call for captain(s) from both teams. Obtain option from captain of team that had second choice in previous extra period, then option from opposing captain. **R** indicates choices to press box as noted above. **H, L,** and **B** perform duties as for coin toss.

*Note: Beginning with third extra period, **R** should remind captains that only a touchdown can score points on a Try.*

Copyright © 2009 by Texas Association of Sports Officials, Inc All rights reserved

No part of this publication may be reproduced, stored in a retrieval system or transmitted in any form or by any means, electronic, mechanical, photocopying, recording or otherwise, without the prior written permission of the publisher.

**H, L B.** Remind head coach for team on your sideline about time-outs. Also, beginning with third extra period, remind them that only a touchdown can score points on a Try.

## **SECTION 25. POST-GAME DUTIES**

### **ARTICLE 1. PROCEDURES**

**ALL A.** Note total elapsed time from initial kickoff to final whistle including all intermissions.

B. Join other officials and leave together. Neither seek nor avoid coaches.

C. Complete any required game reports and mail immediately.

D. It shall be permissible for the home school game administrator to contact the **R** regarding rules interpretations. Judgment calls will not be discussed.

### **ARTICLE 2. INCIDENT REPORTING**

The University Interscholastic League has directed that certain incidents be reported. *ANY EVENT THAT DISRUPTS THE NORMAL FLOW OF THE GAME*, officiated by TASO officials, requires a report. Examples included, but are not limited to:

- Abuse from coaches, players or fans
- Fighting by players, coaches and fans
- Serious Injuries
- Unsafe Playing Conditions
- A half time lasting longer than 28 minutes at a Varsity game
- Coach Ejection – ALL levels of play
- Player Ejection – ALL levels of play
- ALL 15 yard penalties involving the sideline
- ALL 15 yard penalties for unsportsmanlike conduct in sub-varsity play, *especially* middle schools or junior high
- For a Varsity game when no Game Administrator is identified

The game administrator is to be informed of the problem the night of the game, when available. Written reports from each official directly involved in the incident shall be submitted within twenty-four hours and may be filed electronically using the TASO or UIL websites. In addition, the official should notify his/her Chapter leadership of the report.

Reporting of other incidents should be done in accordance with Chapter policies and such policies that TASO may adopt.

## CODE OF ETHICS

### **A GOOD OFFICIAL SHALL:**

Not officiate any game after having had an alcoholic drink that day.

Not converse with crowds at any time before, during or after game intermissions included.

Not make a request to officiate a game to any coach, league, or official thereof.

Not obligate himself/herself to any person affiliated with any game.

Be in good physical condition. Be prompt for appointments. Not be over-officious.

Not accept league assignments for any school he has attended, coached or has any relationship with the affiliates or coach thereof, unless league rules make this permissible.

Not become intimate with coaches or affiliates of teams for whom he might be assigned league games.

Not criticize or attempt to explain other official's judgment on decisions to a coach, team or affiliate thereof.

Not argue with players. If a player asks a question, he should listen to it, and then give a definite and decisive answer, but should not quibble about any situation.

Assist players in the interpretations of rules when such request is made at a proper time.

Give each team his best efforts, as he is the employed representative to administer the rules of the game.

Enthusiastically adhere to the ideals of sportsmanship, qualities of loyalty, courage, unselfishness, self-discipline and authority.

By his actions both on and off the field, is a credit to the profession of officiating.

Copyright © 2009 by Texas Association of Sports Officials, Inc *All rights reserved*

No part of this publication may be reproduced, stored in a retrieval system or transmitted in any form or by any means, electronic, mechanical, photocopying, recording or otherwise, without the prior written permission of the publisher.

**PRE-GAME CONFERENCE IN OFFICIALS DRESSING ROOM**

**ALL** Set watches to correct time. Check equipment (whistles, bean bag, foul markers, game cards, etc.). **R** and **U** will provide information from coaches. Review kickoff time, toss time, unusual plays, players are properly equipped. Review where and how line to gain indicator is to be worked, instruction to Ball Persons, location of testing and marking game balls. Review instructions for clock operators, (Sec 7), and Rules changes. Discuss crew realignment if an official gets injured.

**TEAM DRESSING ROOMS: (HOME TEAM FIRST)**

**R, U** will visit dressing rooms one hour 15 minutes before toss, if possible, otherwise no later than 45 minutes before toss. Give head coaches official time. Obtain name(s) and number(s) of captain(s). Make certain teams are equipped according to rule. Review length of half, 5-minute warning, second half options, and on-field and sideline administration.

**U** Inspect equipment, casts, braces, pads, etc., of each team. Check with head coach or his designated representative for assurance that his players are equipped in compliance with NCAA rules.

**ON THE FIELD:**

**ALL** Inspect field markings and playing conditions ending on your sideline.

**B** Instruct clock operator(s), if not done prior to arrival on field.

**H** Check equipment and instruct assistants.

**R U** Arrange for your captains at toss.

**U R** Spot check equipment.

**B** Instruct clock operator(s) if not done prior to arrival on field.

**B H L** Instruct Ball Persons and identify location of game balls.

**COIN TOSS:**

**R, U** Escort captains to center of field, ready to toss at 3 minutes before kick off.

**H** Stay on sideline.

**L, B** Remain with your teams, holding team's ball pending outcome of toss.

**R** Introduce captains to each other, conduct toss, signal winner, signal options chosen, option waived until second half.

**ALL** After toss move quickly to the center of field. Record results of toss. **U** obtain correct game ball and break to kick off positions.

**SECOND HALF OPTIONS:**

**H L** Obtain second half option from appropriate coach

**L, B** Ensure your team is out and ready to play.

**ALL** Move to normal kickoff positions.

**KICKOFF**

**U** Basic position, with kicker. A's nine yard mark restrictions. Ensure correct number of players on either side of kicker. Instruct kicker, count kicking team players and take position at kicking team restraining line, opposite press box side.

**B** Kicking team's restraining line, press box side. A's nine yard mark restrictions, count kicking team.

Copyright © 2009 by Texas Association of Sports Officials, Inc *All rights reserved*

No part of this publication may be reproduced, stored in a retrieval system or transmitted in any form or by any means, electronic, mechanical, photocopying, recording or otherwise, without the prior written permission of the publisher.

**R** Opposite press box side, outside sideline until area between you and **H** is clear, and then move to sideline.

**L** Press box side, outside sideline until area between you and **B** is clear, and then move to sideline.

**H** Receiving team's restraining line opposite press box, outside and remain outside until ball is kicked, count receivers.

**ALL** Clear restricted area then raise arm to indicate ready. **R** will make ball ready.

**H, U, B** Restraining line fouls, short kicks, kicking team players out of bounds.

**U** Action on and by kicker.

**ALL** Covering official winds the clock. **L, R** discuss end zone split, illegal touching, untouched kick out of bounds, blocking below waist, fair catch, kick catch interference, forward hand-offs, special adjustments for obvious onside kick, free kick after safety same.

### **RUNNING PLAYS:**

**R** Basic position, **R** should, but not mandatory, work on the throwing arm side of the QB, and be at least as wide as tight end and 12-14 yards deep.

**U** Basic position varies to formation, 5-7 yards deep and out of linebackers flow.

**H, L** In side zone extended, be wide, stay on or near the sideline, mark offensive scrimmage line with foot for flankers, off field if necessary.

**B** Approximately 20-25 yards downfield, behind deepest back, favor your key side of the field, action on and by tight end, use keys, responsible for play clock.

**R** Cover runner behind neutral zone, get ball on short out of bounds plays.

**U** Interior linemen, correct numbers, defensive signals. Legal snap, linemen moving, cover inside out and clean up away from ball on runs in side zone. Clip zone, chop blocks.

**H, L** Be wide, use arm/hand signals, action by end/linebackers on your side, legal snap, man in crack back position, chop block, man in motion on your side of snapper, encroachment & offside, action in front of runner toward you, runner on your side beyond zone, when run is away from you clean up action on QB after pitch or handoff. Pitchman when to your side. 9-yard mark restrictions.

**B** Cover from behind defensive backs. Keep play bracketed, help on illegal blocks and action in front of runner. Help cover on downfield out of bounds, 9- yard mark restrictions.

### **PASSES:**

**ALL** Same basic positions and coverage as on running plays.

**R** Action by, on, around passer, intentional grounding, pass from on or behind line, direction on drop-back, work passing arm side of QB is optional. If QB is sacked, mark dead-ball spot with bean bag. PROTECT PASSER.

**U** Know ineligibles, action on or by close in backs, linemen downfield, where first touched. Help on button hook and low short passes.

**H, L** Know ineligibles on your side by position and number, blocking by or on eligible receivers, eligible receivers out of bounds, quick pass direction, sideline yours. Help on first touching. Discuss coverage on sideline passes between **B, H,** and **L.**

**B** Don't get beat deep, end line yours. Keep play between you and flankers, momentum on interception near goal line.

### **PUNTS:**

**R** Kicking foot side of kicker is optional, 5-6 yards outside and even with kicker's final position. Help to spot out of bounds kick if needed.

**U** 8-10 yards deep; defensive player over center, turn with flow, work center.

Copyright © 2009 by Texas Association of Sports Officials, Inc *All rights reserved*

No part of this publication may be reproduced, stored in a retrieval system or transmitted in any form or by any means, electronic, mechanical, photocopying, recording or otherwise, without the prior written permission of the publisher.

**H, L** Same basic position as run or pass. If Team B fouls, know if post scrimmage fouls apply.

**B** Wide side of field, behind and to side of receiver; Responsible for play clock. Bean bag end of kick.

**R** Blocking and action behind line, action by, on or near the kicker.

**H** After snap, hold until ball crosses neutral zone before going downfield.

**H, L** Defensive backs, illegal touch, signals, action in front of ball.

**ALL** Be alert for blocking below waist, short or blocked kick, fair catch interference and illegal touching.

#### **FIELD GOALS AND TRYS:**

**R** Initial position favoring **L** side.

**L, B** Have the call all the way.

**U** Favor **L** side, coverage as any kick.

**H** Line play, neutral zone.

**ALL** On short or partial block, know if ball crossed neutral zone. Kick that does not score, same as punt, fair catch, blocking, etc. **B**, know if and where unsuccessful kick is touched. Review coverage, especially if run or pass develops.

#### **GOAL LINE PLAYS:**

**ALL** Coverage same as any scrimmage play except be ready to move. Be alert for score, sound loud whistle when you rule a score. Move in if not sure; help if pile-up, nearest official will dig out ball. **R** will signal if score.

#### **TIME OUTS:**

**R** Signal time out to press box.

**U** Cover and hold ball position.

**B** Time all time outs, 20 seconds remaining and expiration signals.

**H, L** Team on your side.

#### **MEASUREMENTS:**

**H** Grip chain at spot and bring in.

**L** Mark spot for clip

**U** Stretch chain.

**R** Make ruling

**B** Clear players and officials for press box side view. Hold ball if necessary.

#### **CALLING AND REPORTING FOULS:**

**ALL** Fouls by jersey color or offense/defense or A/B, number/position of offender. Report – who fouled, what was the foul, where did the foul occur and when did it occur. **R** will state foul. **R** will give preliminary signal. Wing officials notify coaches on all fouls number/ position. One official will hold the spot of foul. Check **R**'s options and **U**'s enforcement.

#### **END OF PERIOD:**

**R** Signal end of period, record down, distance and yard line.

**U** Check and accompany **R**. Notify **R** if between downs.

**H** Record yard line of clip, move line to gain indicator.

**B** Move downfield observing teams, go to approximate position for ball. Time all intermissions, 20 seconds remaining and expiration signals.

Copyright © 2009 by Texas Association of Sports Officials, Inc *All rights reserved*

No part of this publication may be reproduced, stored in a retrieval system or transmitted in any form or by any means, electronic, mechanical, photocopying, recording or otherwise, without the prior written permission of the publisher.

**ALL** End of half, record elapsed time and any fouls to carry over to next kickoff.

**R** End of half, from end zone, signal clock operator to start the field clock when field is clear of players and coaches.

**ALL** Leave together at half and at conclusion of game.

**GENERAL PROCEDURES:**

**ALL** Offensive players must comply with 9- yard mark restriction. Forward progress without fanfare, hold until sure **U** has spot. Keep written record of toss, timeouts, major fouls, warnings on sideline administration. Players out of bounds on kicks and passes. Status and position of ball on fouls. Fumbles; report jersey color on possession. Discuss dig-out procedure.

Stop clock signal. Discuss winding signals by **H** and **L**. Know down and distance of each play. Assure **R** makes ball ready. Be sure one-second stop is observed.

Discuss encroachment/offside and sideline coverage. Correct numbering.

**R, U** Count offense













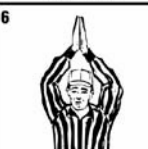
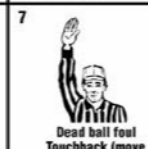
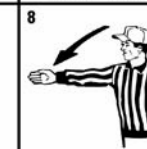
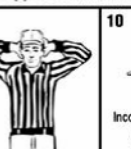
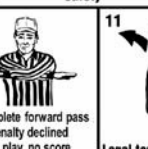
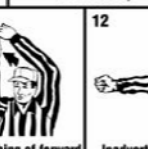

**R** Help defensive signal calling

**B** Count defense

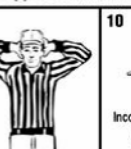
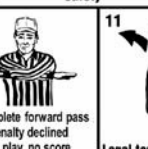
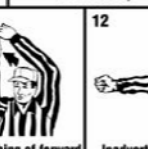
**L, H** Count players from your bench.

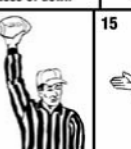
**U** Keep **R** posted near end of quarter when clock is to his back.

**ALL** Hustle!

		<b>OFFICIAL FOOTBALL SIGNALS HIGH SCHOOL AND COLLEGE</b>			
1		2		3	
	Ball ready for play *Untimed down		Start clock		Time-out Discretionary or injury time-out (follow by tapping hands on chest)
4		5		6	
	TV/Radio time-out		Touchdown Field goal Point(s) after touchdown		Safety
7		8		9	
	Dead ball foul Touchback (move side to side)		First down		Loss of down
10		11		12	
	Incomplete forward pass Penalty declined No play, no score Toss option deferred		Legal touching of forward pass or scrimmage kick		Inadvertent whistle (Face Press Box)
13		14		15	
	Disregard flag		End of period		Sideline warning
16		17		18	
	First touching (NFHS) Illegal touching		Uncatchable forward pass (NCAA)		Encroachment (NFHS) Offside defense or free-kick defense (NCAA)
19		20		21	
	False start Illegal formation		Illegal shift - 2 hands Illegal motion - 1 hand		Delay of game
22					
	Substitution infraction				

Copyright © 2009 by Texas Association of Sports Officials, Inc *All rights reserved*

No part of this publication may be reproduced, stored in a retrieval system or transmitted in any form or by any means, electronic, mechanical, photocopying, recording or otherwise, without the prior written permission of the publisher.

**NFHS** OFFICIAL FOOTBALL SIGNALS HIGH SCHOOL AND COLLEGE **NCAA**

23  Failure to wear required equipment	24  Illegal helmet contact	27  Unsportsmanlike conduct Noncontact foul	28  Illegal participation
29  Sideline interference (Face Press Box)	30  Running into or Roughing kicker or holder	31  Illegal batting/kicking (Followed by pointing toward toe for kicking)	32  Invalid fair catch signal (NFHS) Illegal fair catch signal
33  Forward pass interference Kick catching interference	34  Roughing passer	35  Illegal pass/forward heading (Face Press Box)	36  Intentional grounding
37  Ineligible downfield on pass	38  Personal foul	39  Clipping	40  Blocking below waist Illegal block
41  Chop block	42  Holding/obstructing Illegal use of hands/arms	43  Illegal block in the back	44  Helping runner Interlocked blocking
45  Grasping face mask or helmet opening	46  Tripping	47  Disqualification	

NOTE: Signals number 25 and 26 are for future expansion.

Copyright © 2009 by Texas Association of Sports Officials, Inc *All rights reserved*

No part of this publication may be reproduced, stored in a retrieval system or transmitted in any form or by any means, electronic, mechanical, photocopying, recording or otherwise, without the prior written permission of the publisher.